 A330 <small>SIMULATOR</small> FLIGHT CREW OPERATING MANUAL	OXYGEN	1.35.00	P 1
	CONTENTS	SEQ 001	REV 04

35.00 CONTENTS

R 35.10 GENERAL

35.20 FIXED OXYGEN SYSTEM FOR COCKPIT

- DESCRIPTION 1
- CONTROLS AND INDICATORS 4

35.30 FIXED OXYGEN SYSTEM FOR CABIN

- DESCRIPTION 1
- CONTROLS AND INDICATORS 3

R 35.40 PORTABLE OXYGEN SYSTEM

R 35.50 ELECTRICAL SUPPLY

AIRBUS TRAINING  A330 SIMULATOR FLIGHT CREW OPERATING MANUAL	OXYGEN	1.35.10	P 1
	GENERAL	SEQ 001	REV 04

DESCRIPTION

- The oxygen system consists of:
- a fixed oxygen system for the cockpit
 - a fixed oxygen system for the cabin
 - a portable oxygen system.

The oxygen system supplies adequate breathing oxygen to the crew and passengers in case of depressurization or the presence of smoke or toxic gas.



DESCRIPTION

The cockpit's fixed oxygen system consists of :

- One high-pressure cylinder in the left-hand lower fuselage.
- One pressure regulator, connected directly to the cylinder that delivers oxygen, at a pressure suitable for users.
- Two overpressure safety systems to vent oxygen overboard, through a safety port, if the pressure gets too high.
- A supply solenoid valve that allows the crew to shut off the distribution system.
- Four full-face quick-donning masks, stowed in readily-accessible boxes adjacent to the crewmembers' seats (one at each seat).
- One filling port for external oxygen replenishment (as installed).

OPERATION

The crewmember squeezes the red grips to pull the mask out of its box, and this action causes the mask harness to inflate.

A mask-mounted regulator supplies a mixture of air and oxygen or pure oxygen, or performs emergency pressure control. With the regulator set to NORMAL, the user breathes a mixture of cabin air and oxygen up to the cabin altitude at which the regulator supplies 100 % oxygen. The user can select 100 %, in which case the regulator supplies pure oxygen at all cabin altitudes.

If the situation calls for it, the user can use the emergency overpressure rotating knob and receive pure oxygen at positive pressure.

The storage box contains a microphone lead, with a quick-disconnect, for connection to the appropriate mask microphone cable.

- R Note : Each mask may have a removable film that protects the visor against scratches.
 R This strip is optional and may be removed from the mask at any time.

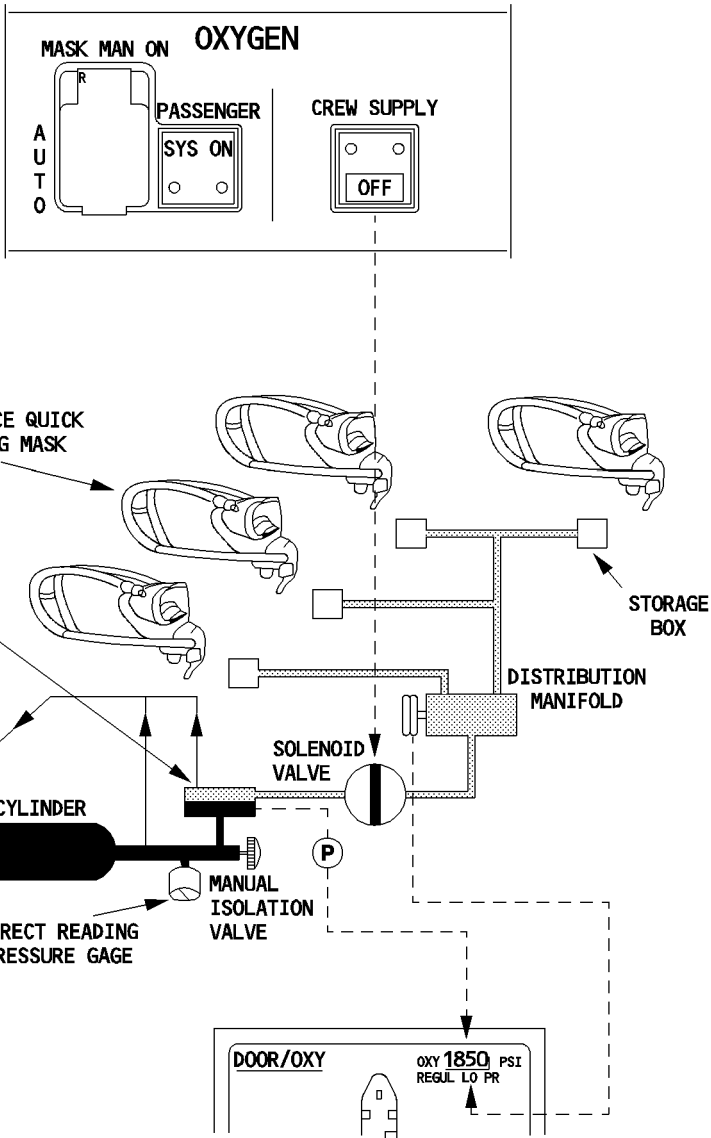

GFCS-01-3520-002-A001AA



MASK DONNING

1 TAKE THE MASK BY SQUEEZING THE RED RIGHT HAND SIDE GRIP

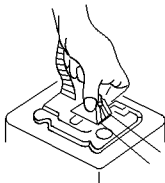

2

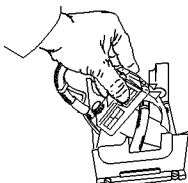

REMOVE THE MASK
THE HARNESS INFLATES

4 DONNING OF THE MASK
(HARNESS INFLATED)



5 RELEASE THE RED HAND SIDE GRIP
HARNESS DEFLATES AND MAINTAINS THE MASK

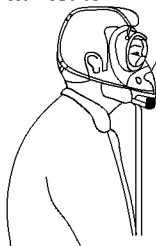

6

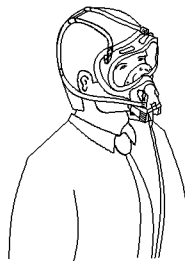

INFLATABLE HARNESS

3

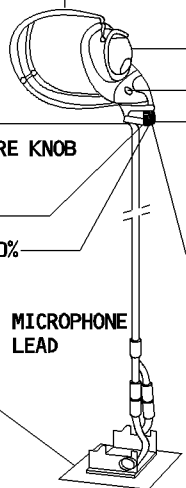

FACE PIECE

MICROPHONE

HARNESS
INFLATION
CONTROL

EMERGENCY
OVERPRESSURE KNOB

RED GRIP

NORMAL / 100%
SELECTOR

DEMAND
REGULATOR

MICROPHONE
LEAD

6FC5-01-3520-003-A001AA

R MASK STOWAGE

- ① - COIL THE HOSE, AND PLACE IT IN THE BOTTOM OF THE STOWAGE BOX.
- ③ - PLACE THE MASK IN THE STOWAGE BOX.
- MAKE SURE THE MASK REGULATOR IS FULLY SEATED AGAINST THE STOP IN THE STOWAGE BOX.

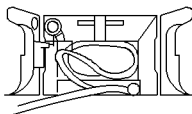

- ② - POSITION THE REMAINING HOSE IN THE MIDDLE OF THE MASK.
- FOLD THE TWO HARNESS PORTIONS TOGETHER.
- ④ - CLOSE THE DOORS, THEN FULLY PRESS THE "RESET TEST" BUTTON.
- ONCE THE "RESET TEST" BUTTON IS RELEASED, CHECK THAT THE "OXY ON" FLAG COMPLETELY DISAPPEARS.
- PRESS THE EMERGENCY PRESSURE SELECTOR, AND CHECK THAT THE BLINKER REMAINS BLACK.

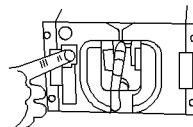
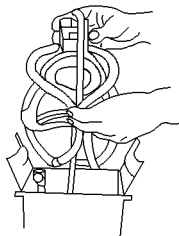

GFC5-01-3520-004-A001AA

GFC5-01-3520-004-B001AA

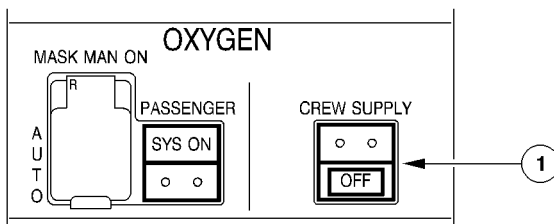
CONTROLS AND INDICATORS**OVERHEAD PANEL****① CREW SUPPLY pushbutton**

This pushbutton controls the solenoid valve.

On : The valve is open, and supplies low pressure oxygen to the masks (normal position in flight).

OFF : The valve is closed, and the white light comes on.



LATERAL CONSOLES

STOWAGE BOX

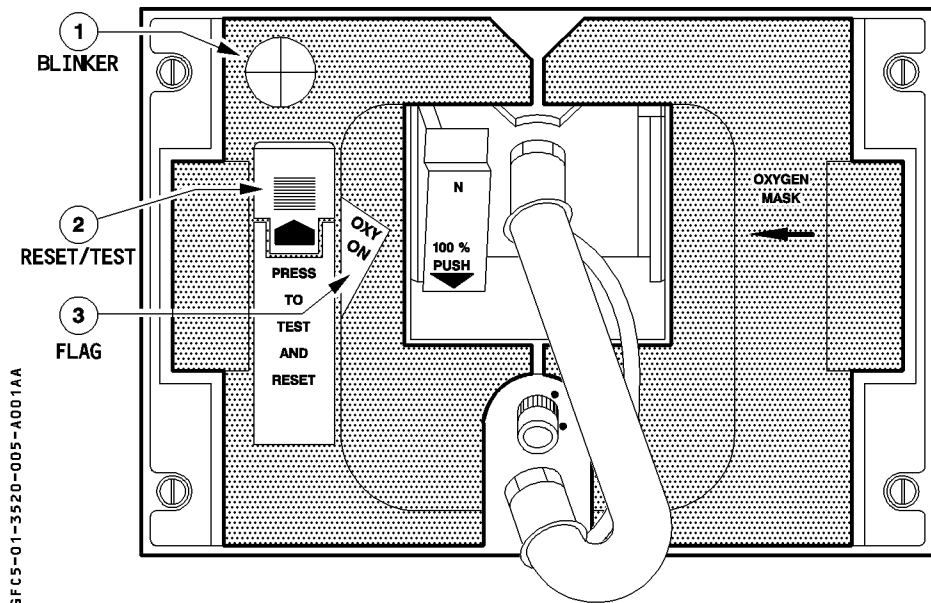

GFC5-01-3520-005-A001AA

① Blinker flowmeter (yellow)

This indicator flashes when oxygen is flowing.

② RESET / TEST control slide

R The crewmember presses the slide, and pushes it in the direction of the arrow to test: the operation of the blinker ; the regulator supply ; system sealing downstream of the valve ; and the regulator sealing and system operation. Pressing the RESET control slide, after the oxygen mask has been used, cuts off the oxygen, and the mask microphone.

③ OXY ON flag

R As soon as the left flap door opens, the mask is supplied with oxygen and, once it closes (mask still supplied with oxygen), the "OXY ON" flag appears.

CREW OXYGEN MASK

R

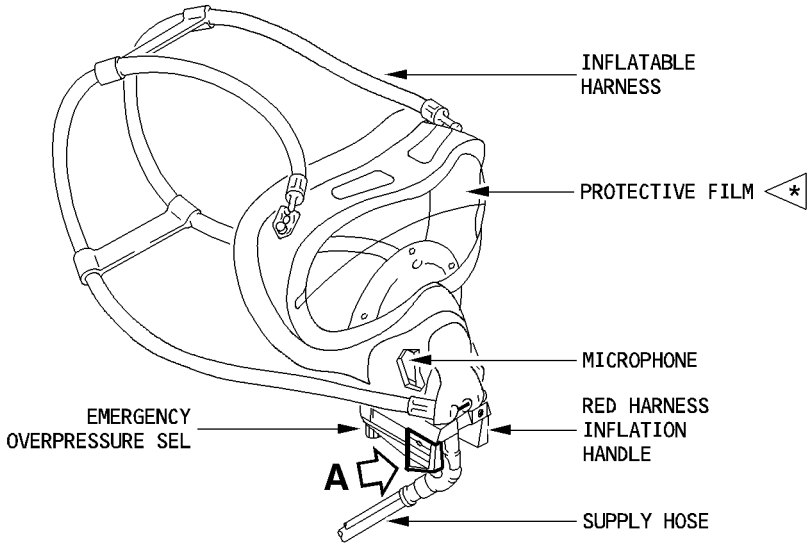

GFC5-01-3520-006-A001AA

PRESSURE REGULATOR

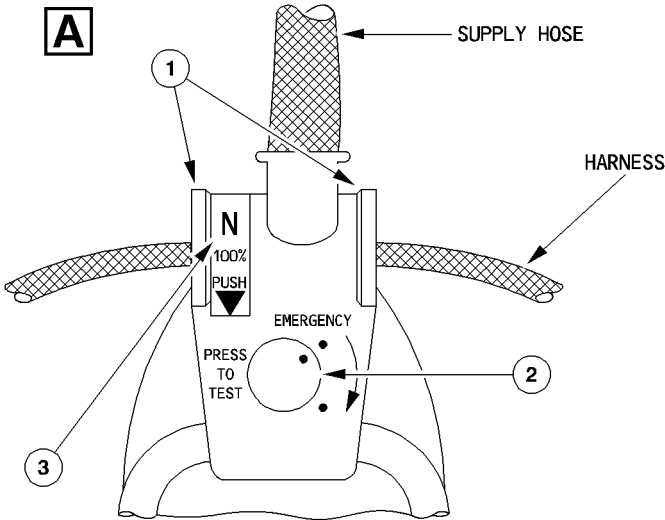

GFC5-01-3520-006-B001AA

AIRBUS TRAINING  A330 SIMULATOR FLIGHT CREW OPERATING MANUAL	OXYGEN		1.35.20	P 7
	FIXED OXYGEN SYSTEM FOR COCKPIT		SEQ 001	REV 11

① Red grips

Squeezing the righthand side grip unlocks the two-flap door and permits the harness to inflate.

② EMERGENCY pressure selector

Use of this selector creates an overpressure which eliminates condensation and prevents smoke, smell or ashes from entering the mask.

- Pressing this knob generates an overpressure for a few seconds.
- Turning the knob, in the direction of the arrow, generates a permanent overpressure.

Note : Overpressure supply is automatically started, when cabin altitude exceeds 30000 feet.

③ N/100 % Sel

R This two-position button is locked down (100 % position) when the crewmember pulls
 R the mask out of the stowage. Pushing up the button from underneath releases it, and it
 pops up to the N (normal) position. Pressing it again returns it to 100 %.

100 % The mask delivers 100 % oxygen.

N The mask delivers a mixture of air and oxygen, the content of which varies with cabin altitude. When cabin altitude goes above 35000 feet, the air inlet closes and the wearer breathes 100 % oxygen.

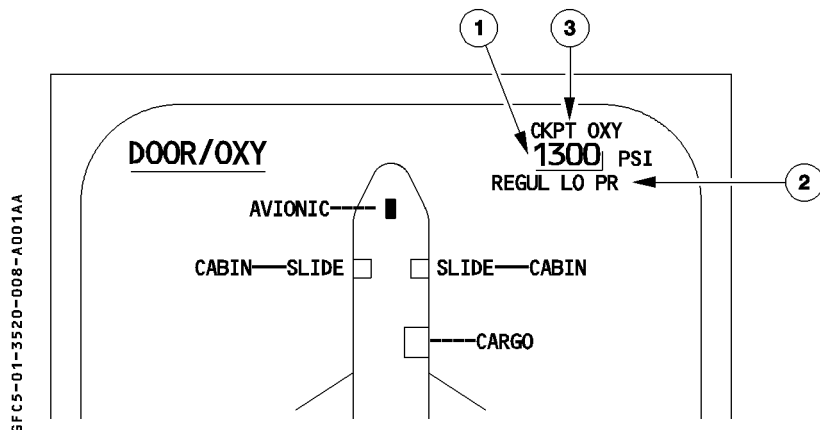
ECAM DOOR/OXY PAGE**① OXY high pressure indication**

Green : When pressure is ≥ 400 psi

Amber : When pressure is < 400 psi

An amber half frame appears when oxygen pressure is < 1500 psi.

In this case, the flight crew must check that the remaining quantity is not below the minimum (refer to OPERATING LIMITATIONS, 3.01.35).

② REGUL LO PR indication

Appears amber if oxygen pressure on the low-pressure circuit is low (50 psi).

③ CKPT OXY indication

Normally white.

Becomes amber when :

- Pressure goes below 400 psi.
- Low oxygen pressure is detected.
- The OXYGEN CREW SUPPLY pushbutton switch on overhead panel is OFF.

AIRBUS TRAINING  A330 SIMULATOR FLIGHT CREW OPERATING MANUAL	OXYGEN	1.35.30	P 1
	FIXED OXYGEN SYSTEM FOR CABIN	SEQ 105	REV 08

DESCRIPTION

The fixed oxygen system in the cabin supplies oxygen to the occupants in case of cabin depressurization.

The system stores its oxygen in interconnected cylinders (5, plus up to 5 additional) behind the right hand sidewall lining in the forward cargo compartment. The oxygen goes to the mask containers in the cabin via two main supply lines and a network of pipes. The containers are above the passenger seats, in the lavatories, in each galley and at each cabin crew station. Each container has 2,3,4 or 5 masks. An altimetric flow regulation device in each mask container controls the flow rate. The Quantity Calculation and Control Unit (QCCU) supplies the value of the average, temperature-compensated pressure for indication on the ECAM system page.

OPERATION

Normally the system is unpressurized. A pneumatically controlled ventilation valve releases any residual pressure. Each container has an electrical latching mechanism that opens automatically to allow the masks to drop, if the cabin pressure altitude exceeds 14 000 feet (+0, -500 feet) the system pressurizes, the masks drop and (if installed) prerecorded instructions sound automatically over the passenger address system. The cockpit crew may operate the system manually.

The generation of oxygen begins when the passenger pulls the mask toward the passenger seat. The mask receives pure oxygen under positive pressure at a rate governed by the cabin pressure altitude and a flow regulating device in each container. The length of time that the oxygen supply will last after the cabin suffers decompression depends on the number of bottles installed, the number of masks in use and the flight attitude profile flown.

R At a cabin pressure altitude of less than 10000 feet, there will be no oxygen flow.

A reset is available for the rearming of the system when the cabin altitude is below 14000 feet and the masks have been returned to their containers.

A manual release tool allows the crew to deploy the masks if the pneumatic door latch release fails it is stored at the cabin attendants' station.

Note : If oxygen system supply lines sustain damage from an engine burst, the supply to cabin oxygen system could be partially lost without any indication of the loss appearing in the cockpit.

R

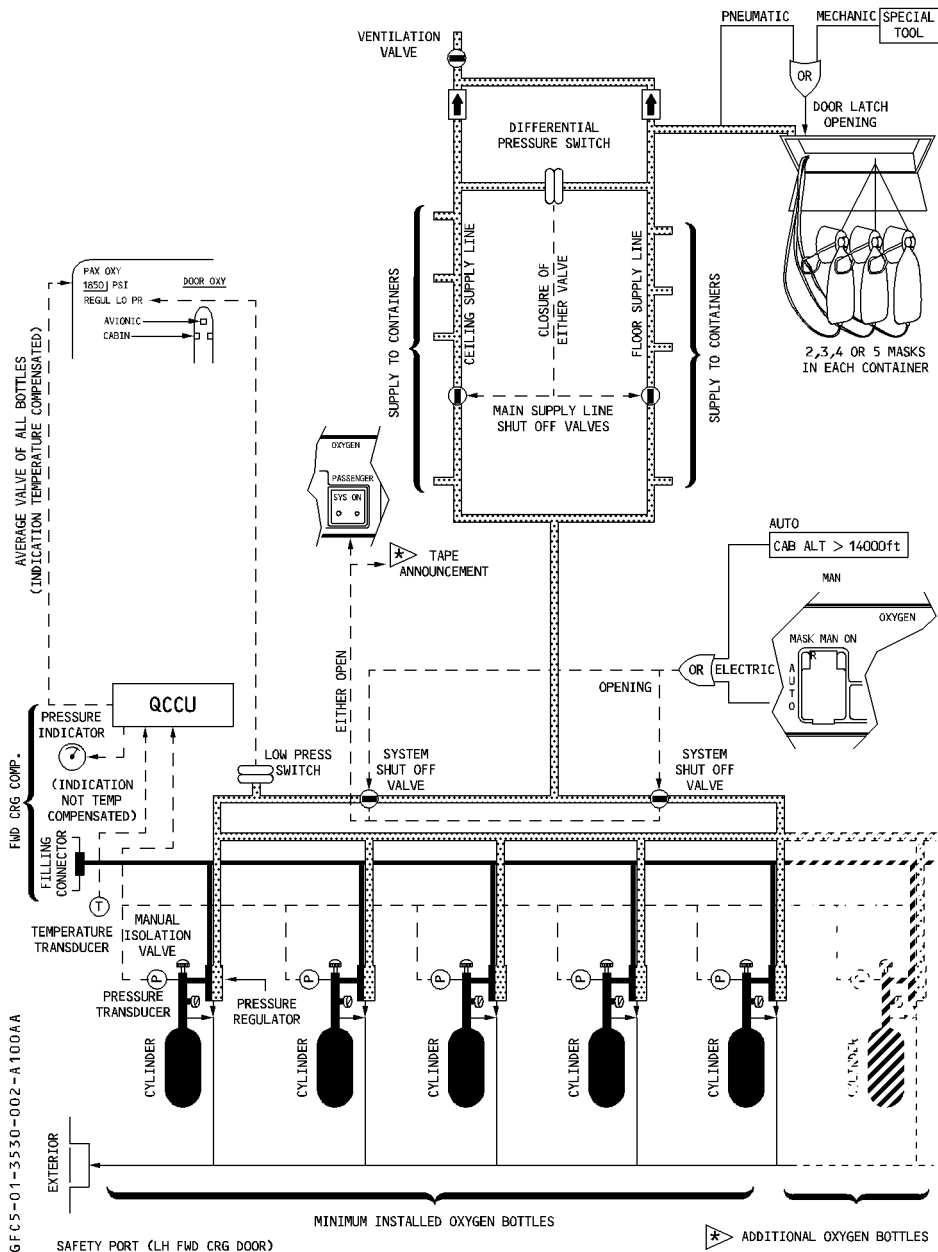



CONTROLS AND INDICATORS

OVERHEAD PANEL

6FC5-01-3530-003-4100AA

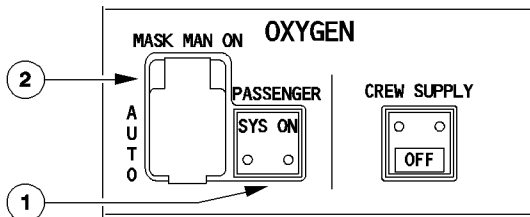

① PASSENGERS SYS ON It

This white light comes on when at least one of the system shut off valves is open and remains on until someone pushes the RESET pushbutton (see maintenance panel, below).

② MASK MAN ON pb

The guard keeps this button in the AUTO position

AUTO : Pressure is applied to the cabin oxygen system automatically when cabin altitude exceeds 14 000 feet.

Pressed : Pressure is applied to the cabin oxygen system.

MAINTENANCE PANEL

6FC5-01-3530-003-8100AA

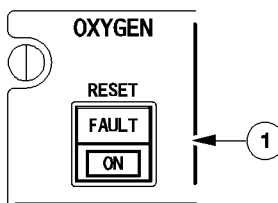

① RESET pb sw

The maintenance crew uses this pushbutton to reset the control circuit after the system has operated

ON : This white light comes on, and the PASSENGER SYS ON light goes off and (if installed) the tape announcement stops.

The system shut off valves close and the main supply line shut off valves open.

The ON light goes off when the reset is completed (3 seconds).

FAULT : This amber light comes on when the reset failed.

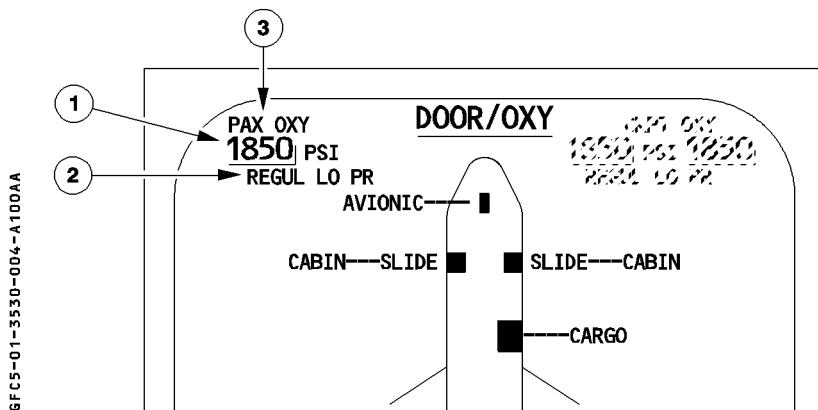
ECAM DOOR/OXY PAGE**① OXY high pressure indication**

Green (steady) : When pressure is ≥ 1200 psi

Green (pulsing) : When pressure is ≥ 200 psi and < 1200 psi

Amber : When pressure is < 200 psi

An amber half frame appears when oxygen pressure is < 1600 psi

② REGUL LO PR indication

Appears amber if :

- the oxygen pressure on the low-pressure circuit is low (64 psi), or if the low pressure switch fails.
- one of the system shut off valves is not fully closed and the system has not been activated.
- one of the main supply line shut off valves is not fully open and the system has not been activated.
- both main supply line shut off valves are closed when the system has been activated.

③ PAX OXY indication

Normally white

Becomes amber when : – Pressure goes below 200 psi.

- Low oxygen pressure is detected on the low pressure circuit.



DESCRIPTION

FLIGHT CREW'S PORTABLE OXYGEN SYSTEM

The smoke hood on the left back side of the cockpit protects the eyes and respiratory system of one member of the flight crew while he is fighting a fire, or if smoke or noxious gases enter the cabin, or if the cabin loses pressure.

The smoke hood is equipped with one oxygen cylinder and one CO₂ absorption system which furnish an effective time of use of 15 minutes.

A « ready for use » status of the hood is ensured by checking that the indicator mounted on the hood container is not red.

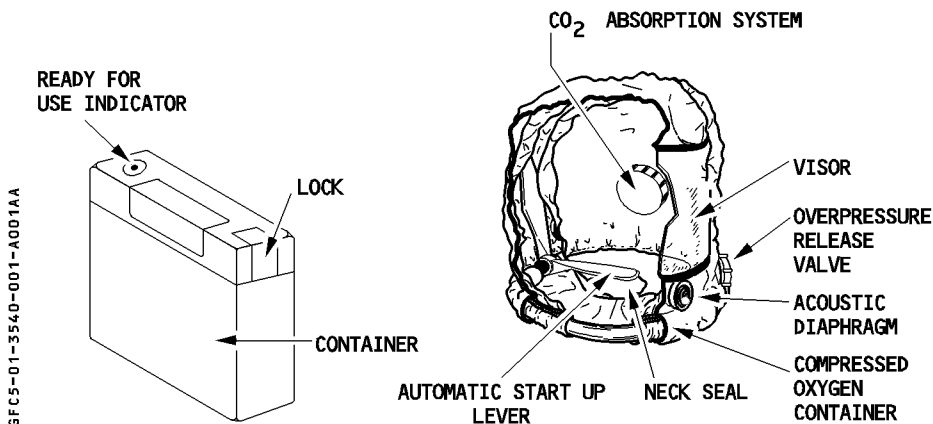

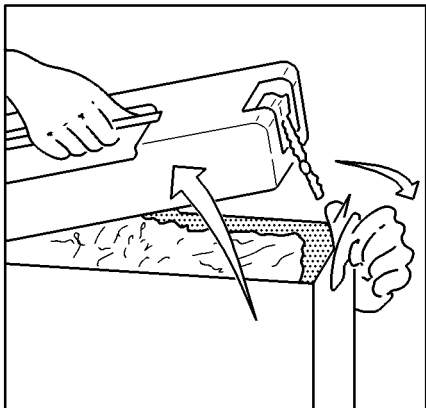
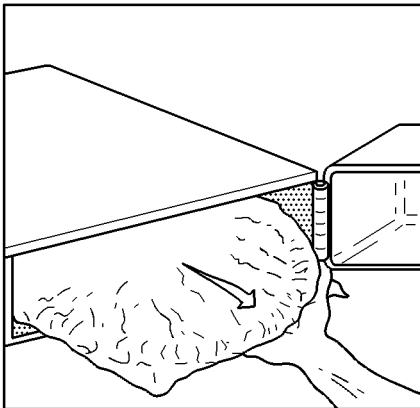
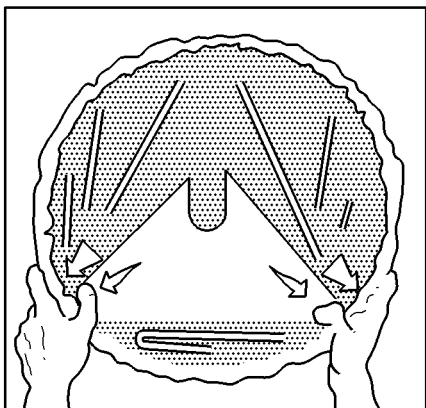
USING THE HOOD**1 OPEN THE HOOD CONTAINER****2 REMOVE THE HOOD AND OPEN THE PROTECTIVE BAG****3 ENLARGE THE NECKSEAL AS INDICATED****4 THE OXYGEN SUPPLY IS AUTOMATICALLY ACTIVATED WHEN THE HOOD IS PUT**



BUS EQUIPMENT LIST

FOR INFO

	NORM			EMER ELEC		
	AC	DC	DC BAT	AC ESS	DC ESS	HOT
CREW OXY CTL					SHED	
PAX OXYGEN	ACTUATION			X		
	AUTOCONTROL				X	