



31.00 CONTENTS

31.05 EIS GENERAL

– INTRODUCTION	1
– COCKPIT ARRANGEMENT	1
– ARCHITECTURE	2
– CONTROLS AND SWITCHING	4
– RECONFIGURING THE DMC	5
– RECONFIGURING DU _s	5

31.10 ECAM DESCRIPTION

– ECAM DU ARRANGEMENT	1
– COLOR CODE	2
– WARNING / CAUTION CLASSIFICATION	2
– PRIORITY RULES	3
– TYPES OF FAILURES	3
– AURAL INDICATORS	4

31.15 INDICATIONS ON E / WD

– GENERAL	1
– INDEPENDENT FAILURE	2
– PRIMARY AND SECONDARY FAILURES	2
– FLIGHT PHASES	3
– MEMO	4
– CONFIGURATION WARNINGS	5

31.20 INDICATIONS ON SD

– GENERAL	1
– SYSTEM PAGES	1
– STATUS PAGE	4
– PERMANENT DATA	5

31.25 ECAM SEQUENCE

– GENERAL	1
– EXAMPLE	2

31.27 OEB REMINDER

– GENERAL	1
– DESCRIPTION	1
– OEB DATABASE	4

31.30 ECAM CONTROLS

– ECAM CONTROL PANEL	1
– ECAM SWITCHING PANEL	4
– ATTENTION-GETTERS	5

31.40 INDICATIONS ON PFD

– GENERAL	1
– SPECIFIC GROUND INDICATIONS	2
– ATTITUDE DATA	3
– AIRSPEED	5
– ALTITUDE	11
– VERTICAL SPEED	15
– HEADING	16
– FLIGHT PATH VECTOR	18
– GUIDANCE	19
– TRAJECTORY DEVIATION	21
– FLIGHT MODE ANNUNCIATOR	25
– ALTITUDE ALERT	27
– FLAGS AND MESSAGES DISPLAYED ON PFD	28
– TCAS (refer to 1.34)	

31.45 INDICATIONS ON ND

– GENERAL	1
– ROSE MODES	2
– ROSE LS MODE	5
– ROSE VOR MODE	7
– ROSE NAV MODE/ARC MODE	8
– PLAN MODE	15
– WEATHER RADAR	16
– PREDICTIVE WINDSHEAR SYSTEM ◀	17
– ENGINE STANDBY PAGE	18
– FLAGS AND MESSAGES DISPLAYED ON ND	19
– EGPWS ◀	23

31.50 EFIS CONTROLS

– EFIS CONTROL PANEL	1
– EFIS DMC PANEL	3
– CHRONOMETER	4

31.55 CLOCK

– GENERAL	1
– CONTROLS AND INDICATORS	2

31.60 FLT RECORDERS

– FLIGHT DATA RECORDING SYSTEM	1
– CONTROLS AND INDICATORS	2
– AIRCRAFT CONDITION MONITORING SYSTEM ◀	3

AIRBUS TRAINING  A330 SIMULATOR FLIGHT CREW OPERATING MANUAL	INDICATING/RECORDING SYSTEMS CONTENTS	1.31.00	P 3
		SEQ 001	REV 15

R 31.75 WARNINGS AND CAUTIONS

- WARNINGS AND CAUTIONS 1
- MEMO DISPLAY 1

31.80 ELECTRICAL SUPPLY

- BUS EQUIPMENT LIST 1



INTRODUCTION

The electronic instrument system (EIS) presents data on six identical display units (DUs):

- The electronic flight instrument system (EFIS) displays mostly flight parameters and navigation data on the primary flight displays (PFDs) and navigation displays (NDs)
- The electronic centralized aircraft monitor (ECAM) presents data on the engine/warning display (E/WD) and system display (SD) :
 - Primary engine indications, fuel quantity, flap and slat position
 - Warning and caution alerts or memos
 - Synoptic diagrams of aircraft systems, and status messages
 - Permanent flight data

COCKPIT ARRANGEMENT

CAPTAIN :

EFIS CONTROL PANEL

NAVIGATION DISPLAY

MASTER WARNING
AND CAUTION LIGHTS

PRIMARY FLIGHT
DISPLAY

FIRST OFFICER :

EFIS CONTROL PANEL

NAVIGATION DISPLAY

MASTER WARNING
AND CAUTION LIGHTS

PRIMARY FLIGHT
DISPLAY

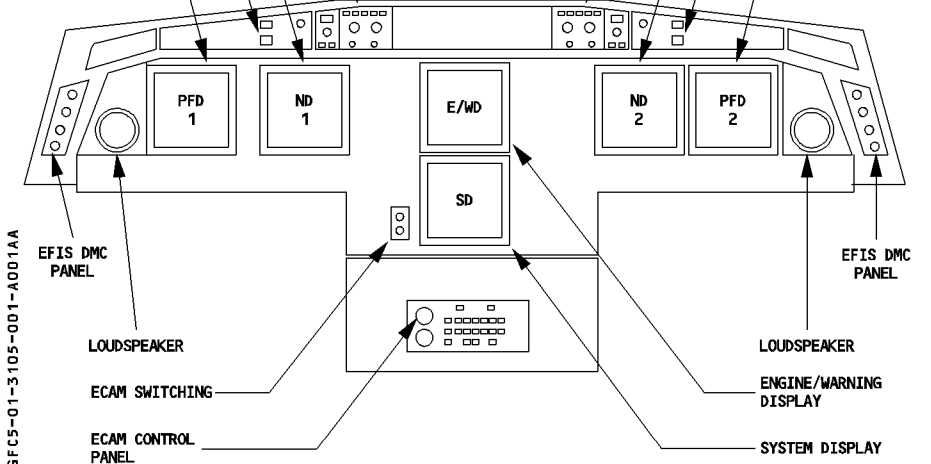

6FC5-01-3105-001-A001AA

ARCHITECTURE

DISPLAY UNIT (DU)

The instrument panels have six identical units. These DUs are full-color cathode ray tubes.

DISPLAY MANAGEMENT COMPUTER (DMC)

Three identical display management computers acquire and process all the signals received from sensors and other computers to generate the images to be displayed on the primary flight displays, navigation displays, engine/warning display, and system display. Each DMC has two independent channels an EFIS channel and an ECAM channel, and is able to drive simultaneously one PFD, one ND, and either of the ECAMs in its engine warning or system status task.

SYSTEM DATA ACQUISITION CONCENTRATOR (SDAC)

The two identical SDACs acquire data, then generate signals. Some of these signals go to the three DMCs, which use them to generate displays of system pages and engines parameters. Others go to the flight warning computers which use them to generate ECAM messages and aural alerts.

FLIGHT WARNING COMPUTER (FWC)

The two identical FWCs generate alert messages, memos, aural alerts, and synthetic voice messages. For this purpose they acquire data :

- directly from aircraft sensors or systems to generate red warnings.
- through the SDACs to generate amber cautions.

The ECAM display units display the alert messages generated by the FWCs.

The FWCs also generate :

- radio altitude callouts.
- decision height callouts.
- landing speed increments.

ATTENTION-GETTERS

The FWCs also drive the attention-getters. Each pilot has a set of these on the panel under the glareshield. They are :

- a master warning light that flashes “MASTER WARN” in red for red warnings
- a master caution light that illuminates “MASTER CAUT” in amber for amber cautions.

LOUDSPEAKER

The communication loudspeakers announce aural alerts and voice messages, and do so even when they are turned off.

EIS BLOCK DIAGRAM

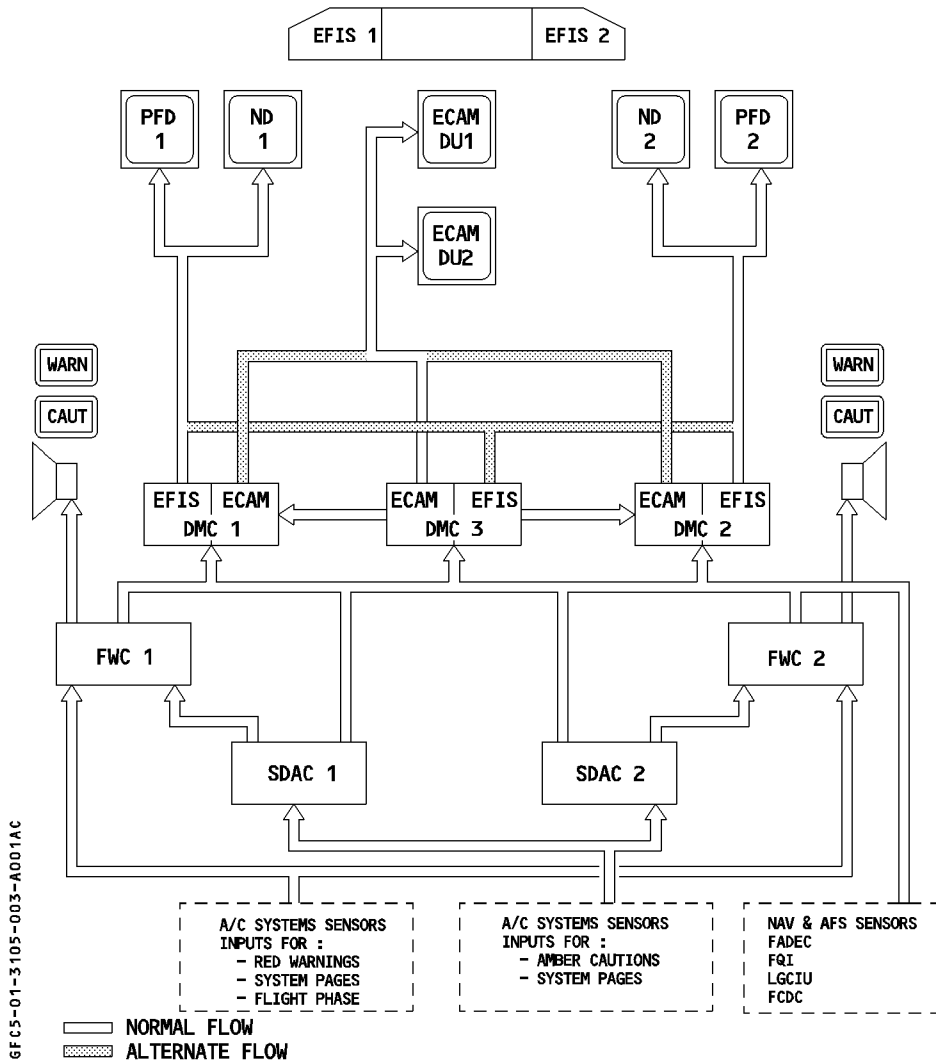

**CONTROLS AND SWITCHING****ECAM CONTROL PANEL (ECP)**

This panel allows the pilot to have the ECAM display units display either warning and caution messages or system and system status images.

ECAM DMC SWITCHING

A switch on the ECAM SWITCHING panel which is on the main instrument panel allows the flight crew to replace the DMC 3 with DMC 1 or DMC 2.

ECAM/ND SWITCHING

A switch on the ECAM SWITCHING panel allows the flight crew to transfer the ECAM system display to either the captain's or the first officer's navigation display.

PFD/ND SWITCHING

A PFD/ND XFR pushbutton on each side console allows the pilot to swap displays on respective onside DUs.

EFIS DMC SWITCHING

A switch on each side console allows the pilot to manually select the DMC 3 or the opposite DMC for supply of data to the onside PFD/ND.



RECONFIGURING THE DISPLAY MANAGEMENT COMPUTER (DMC)

In normal operation :

- DMC 1 supplies data to the captain's PFD and ND.
- DMC 2 supplies data to the first officer's PFD and ND.
- DMC 3 supplies data to the upper and lower ECAM DU.

If a DMC fails (corresponding DU shows a diagonal line), the flight crew can replace DMC 1 or 2 with DMC 3 by turning the EFIS DMC selector on the EFIS DMC panel to 3.

In case of DMC 3 failure, the DMC 1 automatically takes over and supplies the ECAM DUs provided the ECAM SWITCHING selector is in AUTO position.

RECONFIGURING DISPLAY UNITS (DUs)

FAILURE OF UPPER ECAM DU (OR CTL/BRIGHTNESS KNOB TURNED TO OFF)

If the upper ECAM display fails or is switched off :

- The engine/warning page automatically replaces the system/status page on the lower ECAM DU.

The flight crew can have the system/status page displayed by :

- using the "ECAM/ND XFR" switch on the ECAM SWITCHING panel to move it to a navigation display unit (NDU), or
- pushing and holding (for a maximum of 3 minutes) the related system page pushbutton on the ECAM control panel to display it temporarily on the lower ECAM DU (in place of the engine/warning page).

FAILURE OF LOWER ECAM DU (OR CTL/BRIGHTNESS KNOB TURNED TO OFF)

If the lower ECAM display fails or is switched off, the flight crew can have the system/status page displayed by :

- using the "ECAM/ND XFR" switch on the ECAM SWITCHING panel to display it on NDU, or
- pushing and holding (for a maximum of 3 minutes) the related system page pushbutton on the ECAM control panel to display it temporarily on the upper ECAM DU (in place of the engine/warning page).

FAILURE OF BOTH ECAM DUs

If both ECAM displays fail, the flight crew may :

- R – use the "ECAM/ND XFR" on the ECAM SWITCHING panel to display the engine/warning page on a navigation display, and if needed
- R – push and hold (for a maximum of 3 minutes) the related system page pushbutton on the ECAM control panel to display the system/status page temporarily on a ND.

PFDU/NDU RECONFIGURATION

If a PFDU fails, the system automatically transfers the PFD image to the NDU.

The pilot can also make this transfer manually by :

- turning the PFD ON-OFF/brightness control OFF, or
- pressing the PFD/ND/XFR pushbutton, which cross-changes the images between the PFDU and the NDU.

If an NDU fails, the pilot can use the PFD/ND/XFR pushbutton to transfer the ND image to the PFDU.

DU RECONFIGURATION

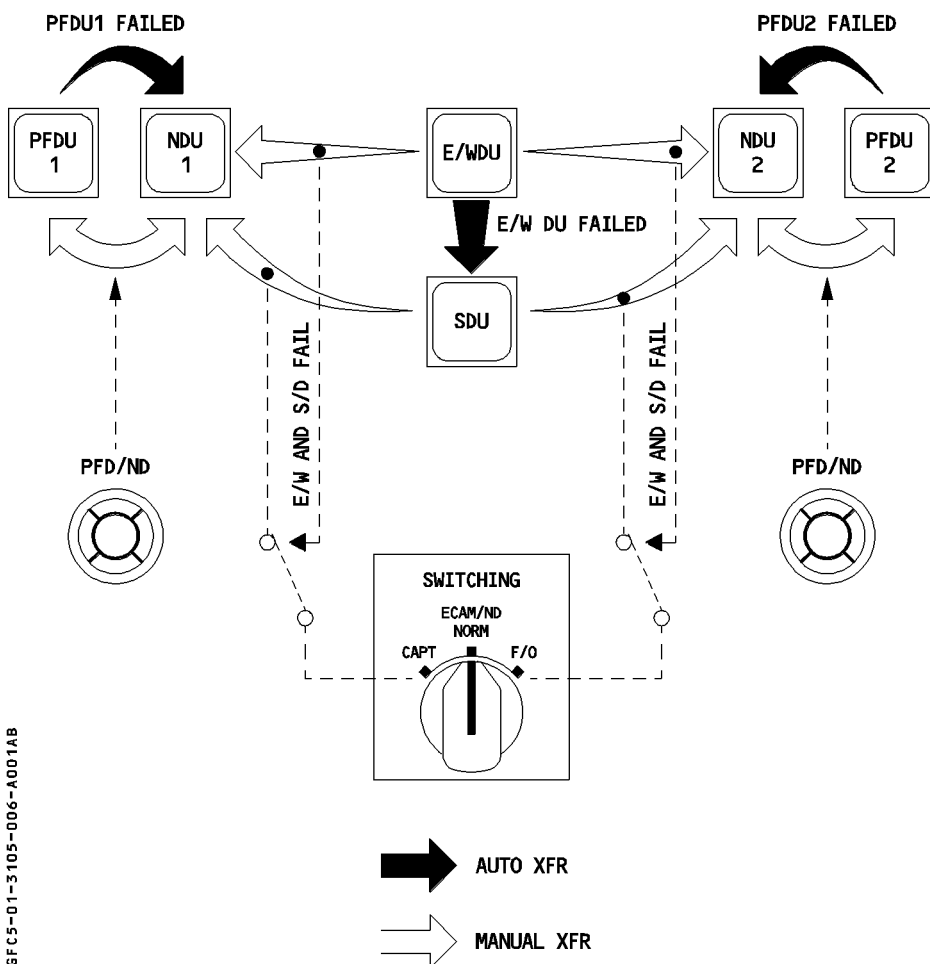

GFC5-01-3105-006-A001AB



ECAM DU ARRANGEMENT

The ECAM has two display units :

- one for the engine/warning display (E/W/D).
- one for the system/status display (SD).

Engine / warning display

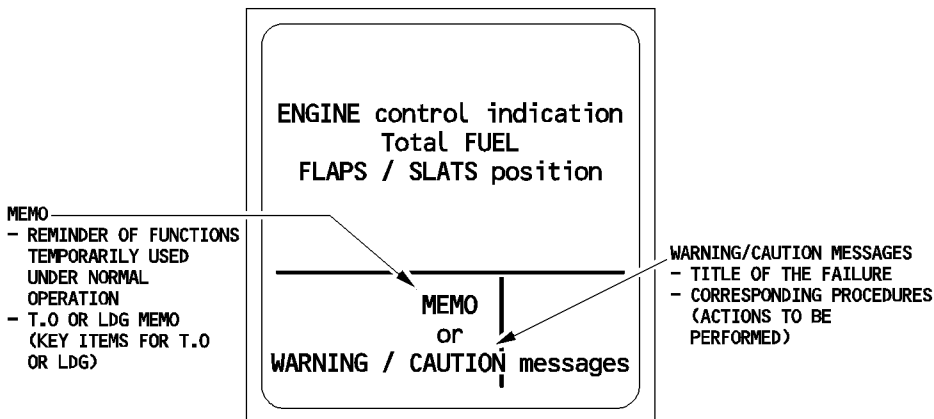

System display

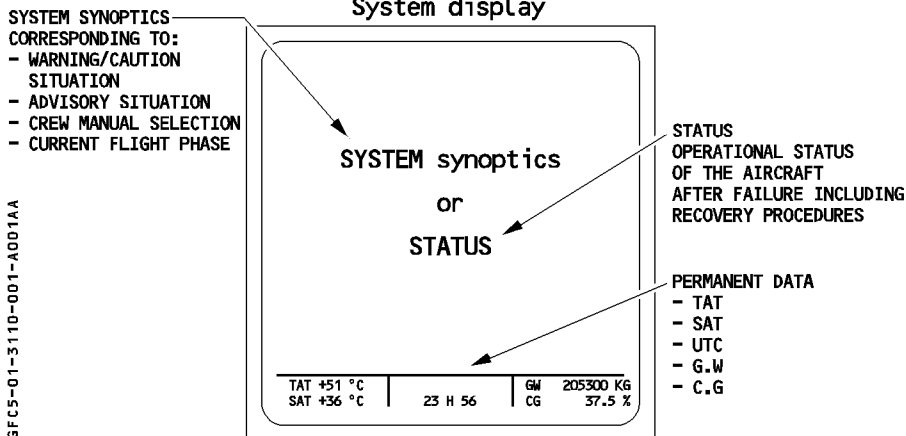

6FC5-01-3110-001-A001AA

COLOR CODE

The ECAM display uses a color code that indicates the importance of the failure or the indication.

RED : The configuration or failure requires immediate action.

AMBER : The flight crew should be aware of the configuration or failure, but needs not take immediate action.

GREEN : The item is operating normally.

WHITE : These titles and remarks guide the flight crew as it executes various procedures.

BLUE : These are actions to be carried out, or limitations.

MAGENTA : These are particular messages that apply to particular pieces of equipment or situations (inhibition messages, for example).

WARNING / CAUTION CLASSIFICATION

	LEVEL	SIGNIFICATION	AURAL	VISUAL
FAILURE MODE	Level 3	Red warning: The configuration or failure requires immediate action : – Aircraft in dangerous configuration or limit flight conditions (eg: stall, α/speed) – System failure altering flight safety (eg : Eng fire, excess cab alt)	Continuous Repetitive Chime (CRC) or specific sound or synthetic voice	– MASTER WARN light red flashing, or specific red light – Warning message (red) on E/WD – Automatic call of the relevant system page on the S/D *
	Level 2	Amber caution : The flight crew should be aware of the configuration or failure, but does not need to take any immediate action. However, time and situation permitting, these cautions should be considered without delay to prevent any further degradation of the affected system : – System failure without any direct consequence on the flight safety (eg : HYD B SYS LO PR).	Single Chime (SC)	– MASTER CAUT light, amber steady : – Caution message (amber) on E/WD – Automatic call of the relevant system page on the S/D * .
	Level 1	Amber caution : Requires crew monitoring : – Failures leading to a loss of redundancy or system degradation (eg : FCDC fault)	NONE	– Caution message (amber) on E/WD, generally without procedure.
INFORMATION	ADVISORY	System parameters' monitoring	NONE	– Automatic call of the relevant system page on the S/D. The affected parameter pulses green.
	MEMO	Information : Recalls normal or automatic selection of functions, which are temporarily used.	NONE	– Green, Amber, or Magenta message on E/WD

* except in some cases

 AIRBUS TRAINING A330 SIMULATOR FLIGHT CREW OPERATING MANUAL	INDICATING/RECORDING SYSTEMS	1.31.10	P 3
	ECAM DESCRIPTION	SEQ 001	REV 04

PRIORITY RULES

There are three priority levels for warnings and cautions :

- A level 3 warning has priority over a level 2 caution which has priority over a level 1 caution.

The FWC observes these priorities.

TYPES OF FAILURES

Independent : a failure that affects an isolated system or item of equipment without degrading the performance of others in the aircraft.

Primary : a failure of a system or an item of equipment that costs the aircraft the use of other systems or items of equipment.

Secondary : the loss of a system or an item of equipment resulting from a primary failure.

AURAL INDICATORS

WARNING SIGNAL	CONDITION	DURATION	SILENCING *
CONTINUOUS REPETITIVE CHIME	RED WARNINGS	PERMANENT	Press * MASTER WARN It
SINGLE CHIME	AMBER CAUTION	1/2 second	
CAVALRY CHARGE	AP DISCONNECTION BY TAKE OVER pb	1.5 second	Second push on TAKE OVER pb
	AP DISCONNECTION DUE TO FAILURE	PERMANENT	PressMASTER WARN It or TAKE OVER pb
TRIPLE CLICK	LANDING CAPABILITY CHANGE or in case of "GPS PRIMARY LOST" (APPR) or in case of mode reversion	1/2 second (3 pulses)	
CRICKET + "STALL" message (synthetic voice)	STALL	PERMANENT	NIL
INTERMITTENT BUZZER	SELCAL CALL	PERMANENT	Press RESET key on ACP
BUZZER	CABIN CALL	3 seconds	NIL
	EMER CABIN CALL	3 seconds REPEATED 3 TIMES	NIL
	MECH CALL	As long as outside pb pressed	NIL
	ACARS ◀ CALL or ALERT	PERMANENT	Message reading on MCDU or Press MASTER CAUT
C CHORD	ALTITUDE ALERT (refer to 1.31.40)	1.5 second or PERMANENT	new ALTITUDE selection or press MASTER WARN pb
AUTO CALLOUT (synthetic voice)	HEIGHT ANNOUNCEMENT BELOW 2500 FT (refer to 1.34.40)	PERMANENT	NIL
GROUND PROXIMITY WARNING (synthetic voice)	(refer to 1.34.70)	PERMANENT	NIL
"WINDSHEAR" (synthetic voice)	WINDSHEAR	REPEATED 3 TIMES	NIL
"PRIORITY LEFT" "PRIORITY RIGHT" (synthetic voice)	AP TAKE OVER pb	1 second	NIL

* All aural warnings may be cancelled by pressing either :

- The EMER CANC pushbutton on the ECAM control panel, or
- The MASTER WARN light (except for some warnings like OVERSPEED or L/G NOT DOWN).



AURAL INDICATORS

WARNING SIGNAL	CONDITION	DURATION	SILENCING *
"RETARD"(synthetic voice)	THRUST LEVER NOT IN IDLE POSITION FOR LANDING	PERMANENT	THRUST LEVER
TCAS \triangleleft (synthetic voice)	refer to 1.34.80	PERMANENT	NIL
"SPEED, SPEED, SPEED" (Synthetic voice)	Current thrust is not sufficient to recover a positive flight through pitch control	Every 5 seconds until thrust is increased	THRUST LEVER(s)
"DUAL INPUT" (synthetic voice)	Both sidesticks are moved simultaneously	Every 5 seconds	One sidestick deactivated

* All aural warnings may be cancelled by pressing either :

- The EMER CANC pushbutton on the ECAM control panel, or
- The MASTER WARN light (except for some warnings like OVERSPEED or L/G NOT DOWN).

GENERAL

The E/W/D appears on the upper ECAM display unit (DU).

- The upper part of this DU displays :
 - Engine parameters (refer to 1.70.95).
 - Fuel on board (FOB) (refer to 1.28.20).
 - Position of slats and flaps (refer to 1.27.40).
- The lower part of this DU displays messages generated by the FWC :
 - Warning and caution messages when a failure occurs ;
 - Memos when there is no failure.

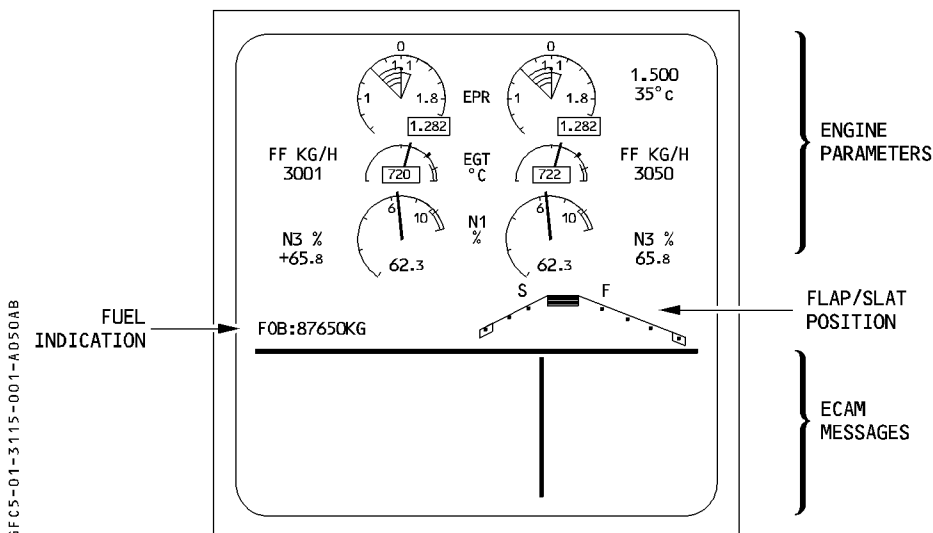

The lower section, which is dedicated to ECAM messages, is divided into two parts of several lines each.

Left part : – Primary or independent warnings and cautions, or
– Memo information.

Right part : – Title of the system affected by a primary or independent warning or caution in case of overflow on the left part, or
– Secondary failure, or
– Memo, or
– Special lines (such as "AP OFF", "LAND ASAP").

As soon as the FWC detects a failure, and if there is no flight phase inhibition active, the E/W/D displays the title of the failure and the actions to be taken.

The action line automatically clears, when the flight crew has executed the required action.

Note : Certain actions will not disappear after execution.

INDEPENDENT FAILURE

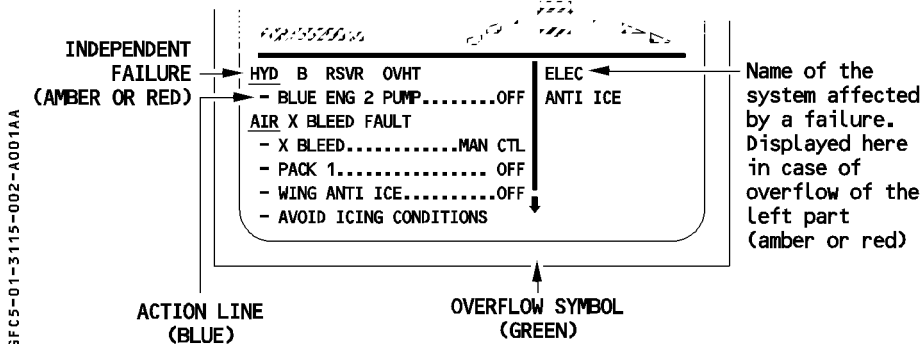

If there are too many ECAM messages for the amount of space available in the lower part of the E/W/D, a green arrow appears at the bottom of the display, pointing down to show that the information has overflowed off the screen. The pilot can scroll down to view additional messages by pushing the CLR pushbutton on the ECAM control panel (on the pedestal, just below the lower ECAM DU).

PRIMARY and SECONDARY FAILURES

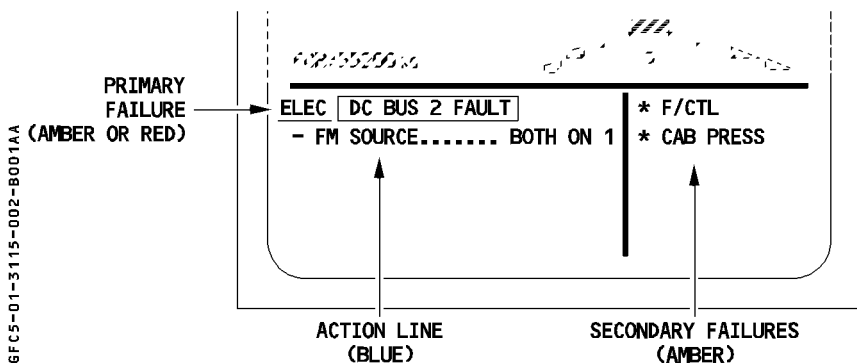

The ECAM DU displays a primary failure as a boxed title. It identifies a secondary failure by putting a star in front of the title of the affected system.

Note : The DU displays the overflow symbol, if primary or secondary failures overflow. In case of ECAM SINGLE DISPLAY, the secondary failures are inhibited.

FLIGHT PHASES**GENERAL**

The FWC divides its functions according to these ten flight phases :

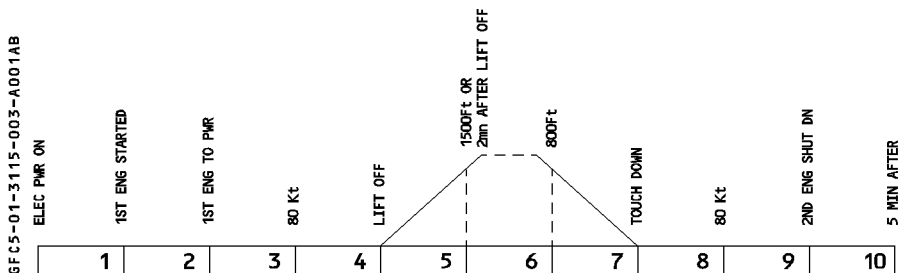

To improve its operational efficacy, the computer inhibits some warnings and cautions for certain flight phases. It does so to avoid alerting the pilots unnecessarily at times when they have high workloads, such as during takeoff or landing. In these two phases, the DU displays magenta memos : "T.O. INHIBIT" (flight phases 3, 4, and 5), and "LDG INHIBIT" (flight phases 7 and 8).

Note : These flight phases are different from and independent of the ones that the FMGC uses.

FLIGHT PHASE INHIBITION

Two cases are possible (for instance) :

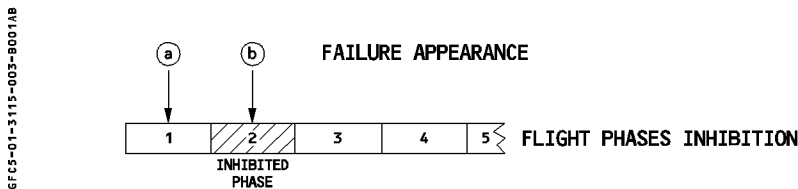

Effect on E/W/D :

- (a) The failure occurs during phase 1. The E/W/D displays the warning immediately and continues to display it as long as the failure is present, even in phase 2.
- (b) The failure occurs during phase 2. The E/W/D displays the warning only when the aircraft has entered phase 3, where it is not inhibited. Then the warning remains displayed as long as the failure is present.

MEMO

DISPLAY

Memos appear in the lower part of the E/WD. They are normally in green, but may be amber in abnormal situations.

Memos list functions or systems that are temporarily used in normal operations.

Each chapter of the "Warning and Cautions" section of this manual lists memo messages.

TO AND LDG MEMOS

During the takeoff and landing phases, the right side of the memo area displays specific T.O. INHIBIT or LDG INHIBIT (magenta) memos.

Takeoff and landing memos are displayed, as follows, during the related flight phases :

GREEN
 BLUE, AS LONG AS ACTION IS NOT PERFORMED;
 DISAPPEARS WHEN ACTION IS PERFORMED.
 BLUE, IF ACTION IS NOT PERFORMED;
 GREEN WHEN ACTION IS PERFORMED.

GFC5-01-3115-004-A100AA

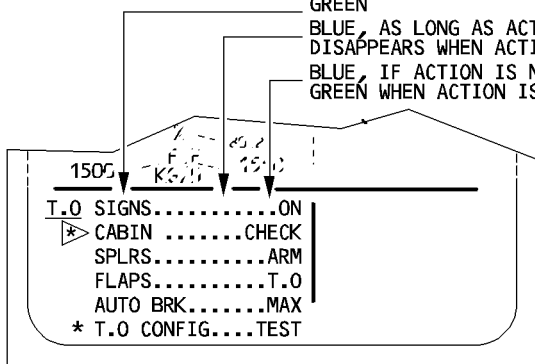

THE T.O MEMO APPEARS:
 -2MN AFTER SECOND ENG START,
 OR
 -WHEN TO CONFIG TEST PB IS
 PRESSED PROVIDED AT LEAST
 ONE ENGINE IS RUNNING.
 IT DISAPPEARS AT TO POWER
 APPLICATION.

*Note : * This line disappears when the test is completed. It is replaced by "T.O. CONFIG NORMAL", if the aircraft configuration is correct.
 Test is requested again, if the configuration becomes abnormal.*

GFC5-01-3115-004-B100AA

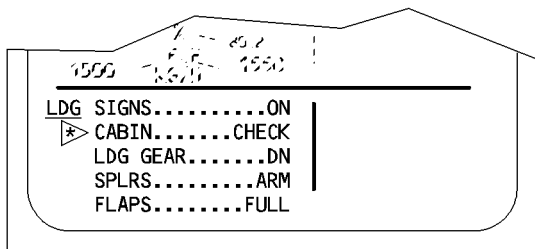

THE LDG MEMO APPEARS
 BELOW 2000FT.
 IT DISAPPEARS AFTER TOUCH
 DOWN (80KT).



CONFIGURATION WARNINGS

The following warnings and cautions appear in the lower part of the E/WD if the aircraft is not in takeoff configuration when the pilot presses the T.O. CONFIG pushbutton on the ECAM control panel or applies takeoff power.

WARNINGS / CAUTIONS	T.O. CONFIG TEST	T.O. POWER
SLATS / FLAPS NOT IN TO CONFIG (R)	TRIGGERED	TRIGGERED
PITCH TRIM NOT IN TO RANGE (R)		
RUD TRIM NOT IN TO RANGE (R)		
SPD BRK NOT RETRACTED (R)		
SIDESTICK FAULT (R) (BY TAKE OVER)		
BRAKES HOT (A)		
DOOR (A)		
PARK BRK ON (R)	NOT TRIGGERED	
REDUCED THR NOT SET (A)		

(R) Red warning

(A) Amber caution

**GENERAL**

The system/status Display (SD) uses the lower ECAM DU to display :

- either an aircraft system synoptic diagram page
- or the STATUS page.

SYSTEM PAGES

The lower ECAM DU can display 14 system pages :

(For description see relevant FCOM chapter)

- ENGINE (Secondary engine parameters)
- BLEED (Air bleed)
- CAB PRESS (Cabin pressurization)
- ELEC AC (AC Electrical power)
- ELEC DC (DC Electrical power)
- HYD (Hydraulic)
- C/B (Circuit Breakers)
- APU (Auxiliary Power Unit)
- COND (Air conditioning)
- DOOR/OXY (Doors/oxygen)
- WHEEL (Landing Gear, Braking, ground spoilers, ...)
- F/CTL (Flight Controls)
- FUEL (Fuel)
- CRUISE (Cruise)

The pilot may manually call up a system page for display on the lower ECAM DU, or the system may automatically display a page.

– Manual :

- The pilot can use the pushbutton on the ECAM control panel to call up any system page, except the CRUISE page, for display at any time.
- The corresponding pushbutton on the ECAM control panel lights up.
- A failure-related display automatically replaces a page the pilot has manually called up.

– Automatic, related to a failure :

- The relevant system page automatically appears, as soon as any fault or malfunction triggers a caution or warning message.

– Automatic, advisory :

- The relevant system page automatically appears, when a parameter drifts out of its normal range.
- The value (shown in green) pulses, as long as it is outside its limits.
- The advisory mode is inhibited in some flight phases.

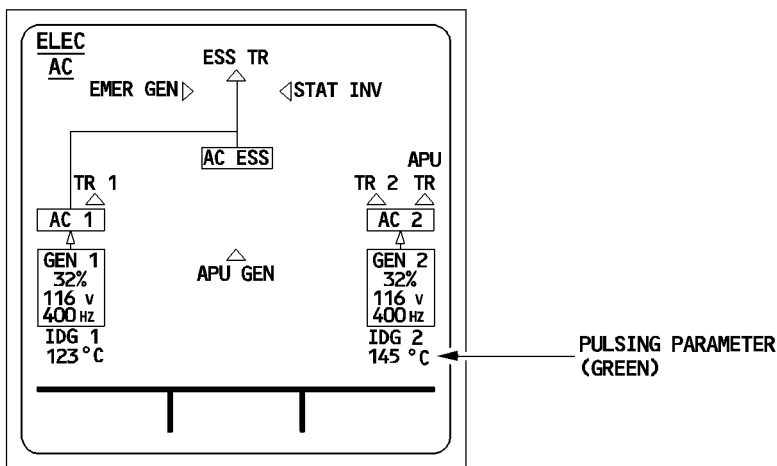

Note : If an advisory is triggered when the ECAM is in the single-display configuration, an advisory message appears on the upper part of the E/WD, and the associated key on ECAM control panel flashes to identify the appropriate system page.

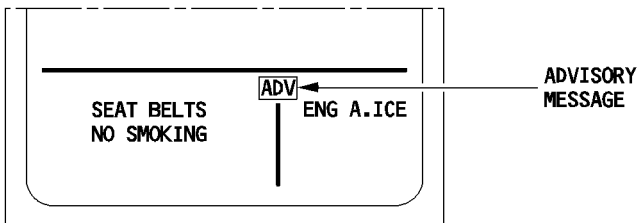

- Automatic, flight phase mode
 - If no other mode is engaged, the SD displays the system page related to the present flight phase, as shown in the following diagram.

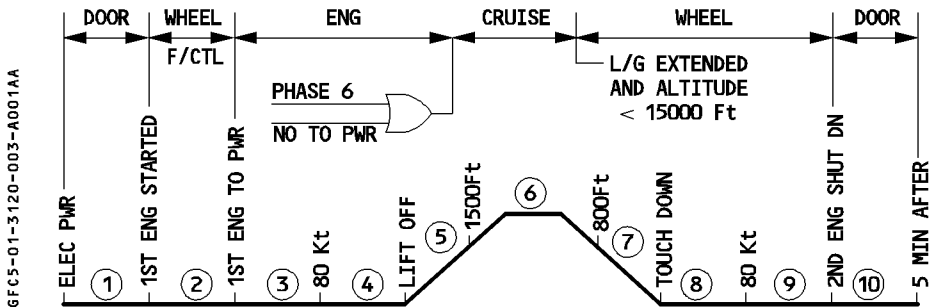

- Phase 2 : The F/CTL page replaces the WHEEL page for 20 seconds when either pilot moves his sidestick (more than 3° in pitch or roll) or when the rudder pedal deflection is more than 22°.
- The APU page appears when the APU MASTER switch is ON. It disappears when APU RPM has been above 95 % for 10 seconds, or when the APU MASTER switch is switched OFF.
- The ENGINE page appears at the beginning of start sequence or when a pilot selects "CRANK". It disappears at the end of the start sequence.

For a description of the ENGINE and AIR indications that appear when the SD is displaying the CRUISE page, see the relevant FCOM chapter.

6FC5-01-3120-003-B001AB

<u>CRUISE</u>	
<u>ENG</u>	F. USED
4260	— KG — 4250
17.5	— QT — 18.0
0.9	— N1 — 1.2
0.6	— N2 — 0.9
<u>AIR</u>	
LDG ELEV AUTO 2500 FT	
Δ P 7.5 PSI	
CKPT	CAB V/S
23 FWD 24 MID 23 AFT 24	500 FT/MIN
22 23 °C	CAB ALT
7500 FT	
TAT -51 °C	GW 205300 KG
SAT -36 °C	23 H 56 GWC 37.5 %

STATUS PAGE

6FC5-01-3120-004-A001AB

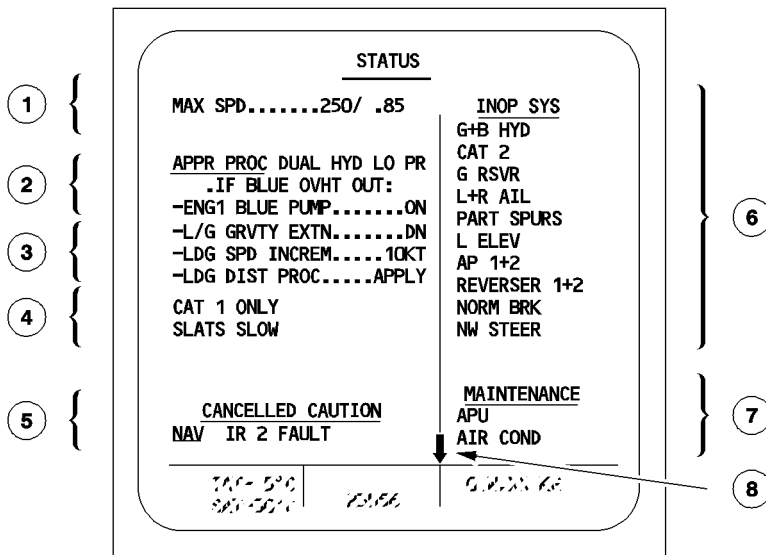

The status page displays an operational summary of the aircraft status after the SD has displayed a failure. As shown in the illustration above, the summary includes :

- ① Limitations (speed, flight level) : Blue
- ② Approach procedures : White/Red or Amber
- ③ Procedures (corrections to apply for landing) : Blue
- ④ Information : Green
- ⑤ Cancelled caution : White
- ⑥ Inoperative system : Amber
- ⑦ Maintenance status : White
- ⑧ Symbol displayed if data overflows the left or right area.

The pilot scrolls the display to view overflow by pressing the CLR pushbutton.

Note : The titles of the different parts of the display are white and underlined.

The STATUS page appears automatically once the crew has cleared all the pages corresponding to the current failure.

The STATUS page also appears automatically during descent when the baro reference is selected or the slats are extended.

The pilot may call up the status page manually by pressing the STS key on the ECAM control panel.

If the STATUS page holds messages other than "CANCELLED CAUTION" or the MAINTENANCE part, the E/WD screen shows "STS" (status reminder).

If the STATUS page holds messages in the MAINTENANCE part at engine shut-down, the "STS" (status reminder) flashes on the E/WD screen.

The screen displays the MAINTENANCE only when the aircraft is on the ground, before engine start-up or after engine shut-down (phases 1 and 10).

PERMANENT DATA

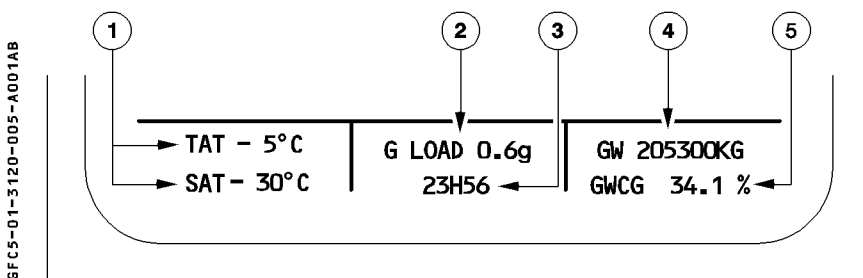

① Temperature

The screen displays total air temperature (TAT) and static air temperature (SAT) in green.

② Messages - G LOAD

The screen displays either of two items, one at a time :

- Load factor (G LOAD), in amber, when the value is above 1.4 g or below 0.7 g.
This display is inhibited during flight phases 1 and 2.
- CHECK SD, in amber, when the DMC detects a discrepancy between acquisition and display on the DU.

③ UTC

The screen displays Universal Time Coordinated (UTC), synchronized with the cockpit clock, in green.

④ GW

The screen displays the Gross Weight (GW) as given by the FCMC, in green. The two last digits are dashed if accuracy is degraded. On ground, the indication is replaced by blue dashes, if no computed data are available.

⑤ GWCG

The screen displays the center of gravity, as given by the FCMC, in green. In case of an EXCESS AFT CG warning, the indication appears in red.

R

AIRBUS TRAINING  A330 SIMULATOR FLIGHT CREW OPERATING MANUAL	INDICATING/RECORDING SYSTEMS ECAM SEQUENCE	1.31.25 SEQ 001	P 1 REV 04
--	--	------------------------	-------------------

GENERAL

If ECAM detects a failure :

- The E/WD displays warning or caution messages.
- The master warning or master caution lights light up (except in the case of a level 1 caution).
- The system sounds an aural signal (except in the case of a level 1 caution).
- The system display (SD) shows the system page for the affected system.
- The CLR pushbutton on the ECAM control panel lights up.

In addition, a local warning light controlled directly by the affected system can light up. After completing remedial procedures, the flight crew must push the CLR pushbutton repeatedly until the displays return to their normal configurations :

- MEMO messages on the E/WD
- The system page related to the present flight phase on the SD.
- The CLR light on the ECAM control panel turned off.

EXAMPLE

1 — THE ECAM DETECTS NO FAILURE

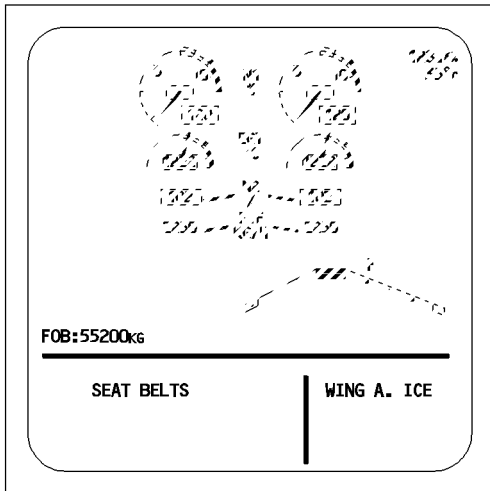

ECAM UPPER DISPLAY (E/WD)

- ENGINE CONTROL PARAMETERS
- FUEL QUANTITY INDICATION
- FLAP/SLAT POSITION

- MEMO INFORMATION

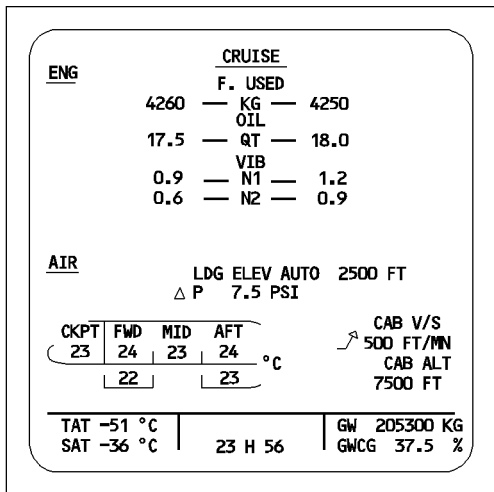

ECAM LOWER DISPLAY (SD)

- FLIGHT PHASE RELATED SYSTEM PAGE (CRUISE PAGE IN THIS EXAMPLE)

- PERMANENT DATA

6FC5-01-3125-002-A001AC

2 — THE ECAM DETECTS A FAILURE

For example, a hydraulic reservoir is overheating.

COCKPIT INDICATIONS

- A single chime sounds.
- Both MASTER CAUTION lights come on and stay on.
- A FAULT light on the overhead HYD panel comes on.
- The memo space on the E/WD displays the message “HYD G RSVR OVHT” and the instruction “G ENG 1 + 2 PUMP OFF”.
- The lower ECAM display (SD) automatically calls up the diagram of the hydraulic systems and displays “OVHT” in amber by the blue system.
- The CLR pushbutton on the ECAM control panel lights up.

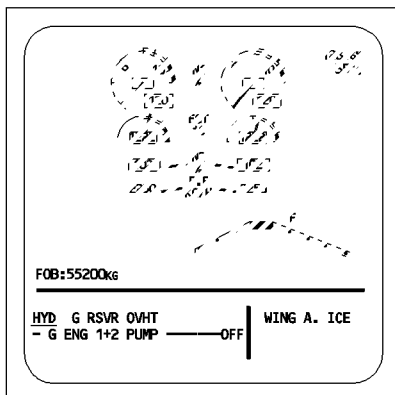

ECAM UPPER DISPLAY (E/WD)

- LEFT PART
 - INDEPENDENT FAILURE
 - TITLE OF THE FAILURE
 - ACTIONS TO BE PERFORMED
- RIGHT PART
 - MEMO INFORMATION

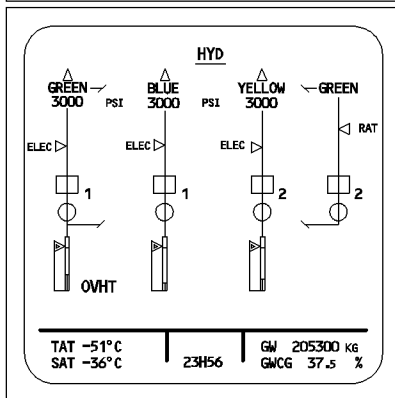

ECAM LOWER DISPLAY (SD)

- SYNOPTIC OF THE AFFECTED SYSTEM AUTOMATICALLY CALLED
- OVHT IS DISPLAYED IN AMBER

6FC5-01-3125-003-A001AC

3 — THE FLIGHT CREW FOLLOWS THE INSTRUCTION DISPLAYED ON THE E/WD

The crew switches off the green ENG 1 and 2 pump, depressurizing the green hydraulic circuit.

COCKPIT INDICATIONS

- A single chime sounds.
- Both MASTER CAUTION lights stay on.
- A FAULT/OFF light on the overhead panel comes on.
- The second part of the message on the E/WD changes to “G SYS LO PR”.
- The system diagram on the SD shows an amber zero for the pressure in the green system, along with the amber “OVHT”.
- The right side of the memo area indicates a secondary failure in the flight control system.
- The CLR pushbutton on the ECAM control panel stays lighted.

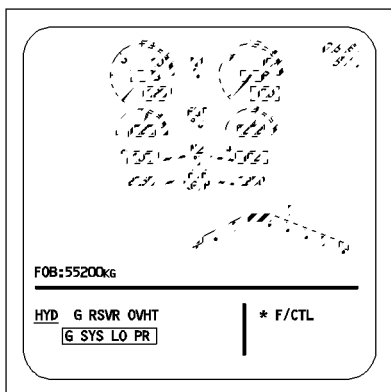

ECAM UPPER DISPLAY (E/WD)

- LEFT PART
 - INDEPENDENT FAILURE AND PRIMARY FAILURE
- RIGHT PART
 - SECONDARY FAILURE

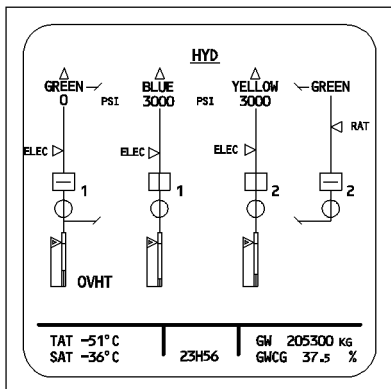

ECAM LOWER DISPLAY (SD)

- THE SYNOPTIC OF THE SYSTEM PAGE IS CHANGED ACCORDING TO THE NEW SYSTEM CONFIGURATION. OVHT AND THE PRESSURE ARE DISPLAYED IN AMBER

GFC5-01-3125-004-A001AC

4 — ONE OF THE PILOTS PUSHES THE CLR PUSHBUTTON ON THE ECP

COCKPIT INDICATIONS

- The CLR pushbutton stays lighted.
- The FAULT/OFF light stays on.
- The hydraulic system messages disappear from the E/WD, and the right side of the memo area indicates a secondary failure in the flight control system.
- The SD automatically calls up the flight control system page, with surface actuator indications associated with the green hydraulic system shown in amber.

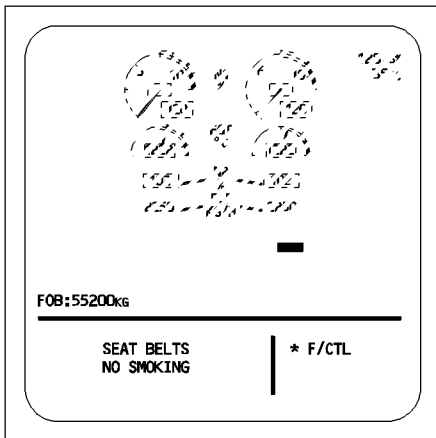

ECAM UPPER DISPLAY (E/WD)

- LEFT PART
 - MEMO INFORMATION
- RIGHT PART
 - SECONDARY FAILURE

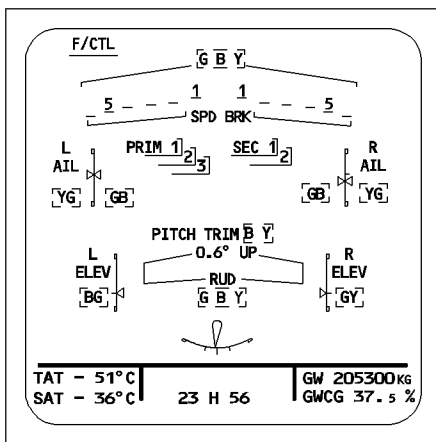

ECAM LOWER DISPLAY (SD)

- F/CTL SYSTEM PAGE AUTOMATICALLY DISPLAYED
- FAULTY SPOILERS (n°1+5) AND SURFACE ACTUATOR PRESSURE INDICATION G ARE DISPLAYED IN AMBER

5 — ONE OF THE PILOTS PUSHES THE CLR PUSHBUTTON A SECOND TIME**COCKPIT INDICATIONS**

- The CLR and STS pushbuttons on the ECP light up.
- The FAULT/OFF lights stay on.
- The memo area on the E/WD returns to normal.
- The STATUS page appears automatically on the SD, displaying the procedures for completing the flight with faulty green system.

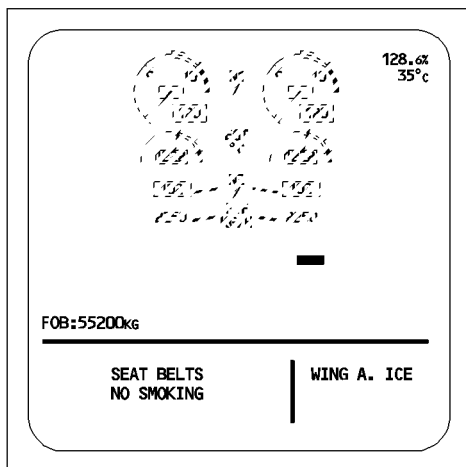
**ECAM UPPER DISPLAY (E/WD)**

- FULL MEMO DISPLAYED

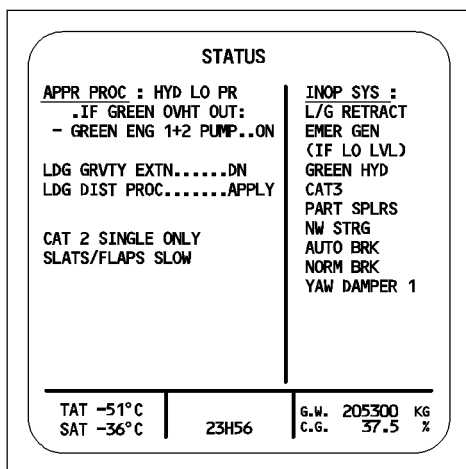
**ECAM LOWER DISPLAY (SD)**

- THE STATUS PAGE IS AUTOMATICALLY DISPLAYED TO
 - PROVIDE THE PROCEDURE TO APPLY FOR APPROACH
 - LIST THE INOPERATIVE SYSTEMS

6 — ONE OF THE PILOTS PUSHES THE CLR PUSHBUTTON A THIRD TIME

COCKPIT INDICATIONS

- The CLR pushbutton light goes out.
- The FAULT/OFF lights stay on.
- A status reminder appears at the bottom of the E/WD.
- The SD automatically calls up the system page for the flight phase.

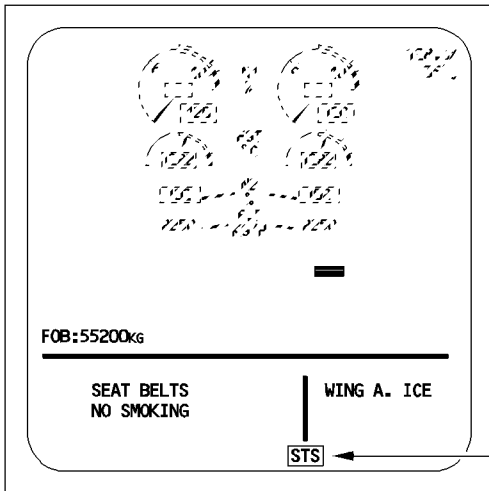

ECAM UPPER DISPLAY (E/WD)

- FULL MEMO DISPLAYED

STATUS REMINDER

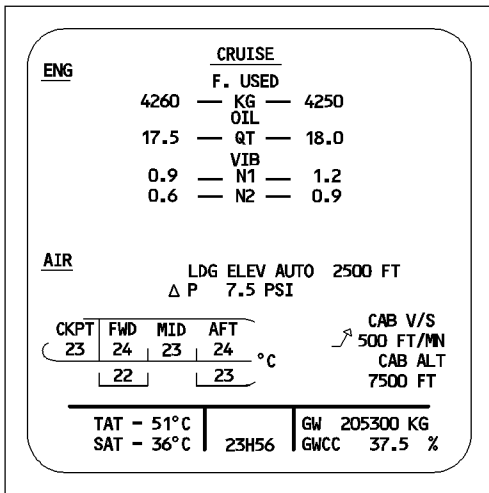

ECAM LOWER DISPLAY (SD)

- RETURN TO THE FLIGHT PHASE
RELATED SYSTEM PAGE :
CRUISE PAGE

6FC5-01-3125-007-A00TAC

GENERAL

The OEB reminder function provides operational help to the crew by enabling them to clearly identify (on the ECAM) all procedures and status messages affected by an OEB. When a situation leading to a warning/caution occurs, a message informs the crew in real time that an OEB exists for the displayed warning and/or status and, consequently, that the procedure and/or status presented on the ECAM is not applicable.

Then the crew must refer to the QRH where the correct information is provided.

DESCRIPTION

The OEB reminder flag may apply to the :

- ECAM procedure only,
- ECAM procedure and corresponding status messages,
- Status message only.

PROCEDURE ONLY AFFECTED

- The ECAM warning title remains unaltered,
- All corresponding actions are suppressed and replaced by the “REFER TO QRH PROC” message.
- The related status messages on the ECAM system display remains unaltered.

COCKPIT INDICATION

<u>AIR PACK1 OVHT</u>	
-REFER TO QRH PROC-	

ECAM UPPER DISPLAY (E/WD)

6FC5-01-3127-001-A100AA

STATUS	
●WHEN PACK OVHT OUT:	<u>INOP SYS</u>
-PACK1.....ON	PACK1

ECAM LOWER DISPLAY (SD)



PROCEDURE AND STATUS AFFECTED

- The ECAM warning title remains unaltered,
- All corresponding actions are suppressed and replaced by the "REFER TO QRH PROC" message.
- The related status messages on the ECAM system display remains unchanged, except for the additional "REFER TO QRH PROC" title.

COCKPIT INDICATION

<p><u>AIR PACK1 OVHT</u></p> <p>-REFER TO QRH PROC-</p>	
---	--

ECAM UPPER DISPLAY (E/WD)

STATUS

<p><u>REFER TO QRH PROC</u></p> <p>●WHEN PACK OVHT OUT:</p> <p>-PACK1.....ON</p>	<p><u>INOP SYS</u></p> <p>PACK1</p>
--	-------------------------------------

ECAM LOWER DISPLAY (SD)

GFC5-01-3127-002-A100AA



STATUS MESSAGE ONLY AFFECTED

- The ECAM warning title remains unaltered,
- The corresponding procedure remains unchanged, except for additional "FOR STS REFER TO QRH" line.
- The related status messages on the ECAM system display remains unchanged, except for additional "REFER TO QRH PROC" title.

COCKPIT INDICATION

6FC5-01-3127-003-A100AA

<p><u>AIR PACK1 OVHT</u></p> <p>-PACK1.....OFF</p> <p>●WHEN PACK OVHT OUT:</p> <p>-PACK1.....ON</p> <p>-FOR STS REFER TO QRH</p>	
--	--

ECAM UPPER DISPLAY (E/WD)

STATUS

<p><u>-REFER TO QRH PROC-</u></p> <p>●WHEN PACK OVHT OUT:</p> <p>-PACK1.....ON</p>	<p><u>INOP SYS</u></p> <p>PACK1</p>
--	-------------------------------------

ECAM LOWER DISPLAY (SD)

**OEB DATABASE**

The OEB database lists the warnings and cautions affected by OEBs.

The OEB database can be :

- Loaded manually on the aircraft via the MCDU, and stored in both FWCs.
- Crossloaded from one FWC to the other FWC.
- Updated by entering a code via the MCDU.
- Checked via the MCDU.

Note : *The code provided on the OEB is designed to ensure that the OEB database is not updated before the OEB is available.*



ECAM CONTROL PANEL

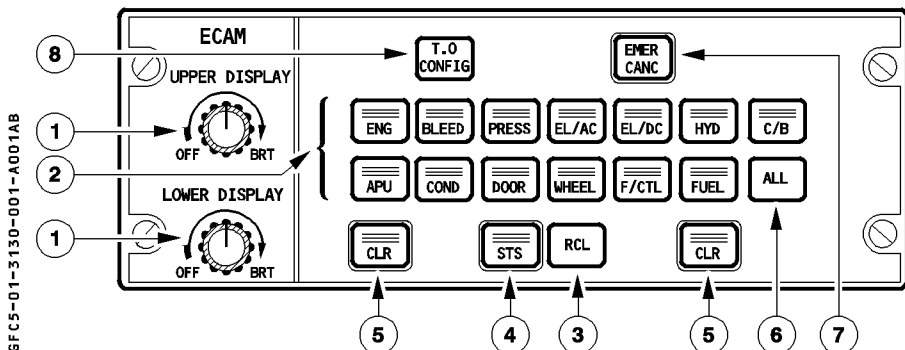

① OFF / BRT knobs

Used to turn the ECAM DUs on and off, and to control their brightness (automatic adjustment of brightness for ambient light conditions is superimposed on this manual control).

Note : When the pilot turns the UPPER DISPLAY knob to OFF, the engine/warning (E/W) display appears on the lower display unit (automatic transfer).

② System page pushbuttons

- Call up the corresponding system pages on the SD.
- Light up, when pushed for manual selection, or when an advisory is detected.
- Call up the aircraft system page corresponding to the present flight phase or the current warning when pushed a second time.

When only one ECAM display is on, the pilot can display a system page for up to 3 minutes by holding the system page pushbutton.

- If an advisory condition arises, the relevant system page is not automatically displayed, but the pushbutton light pulses.
- If an ECAM warning is triggered, the relevant system page is not automatically displayed, and the system page pushbutton does not light up.

③ RCL pushbutton

R

The pilot pushes the RCL pushbutton to call up the warning messages, the caution messages, and the status page, that may have been suppressed by the activation of the CLR pushbutton or by flight-phase-related inhibition.

If there are no suppressed warnings or cautions, the E/WD shows "NORMAL" for five seconds.

If the pilot holds this pushbutton down for more than three seconds, the E/WD displays any caution messages that were suppressed by the EMER CANC pushbutton.

④ STS (status) pushbutton

The pilot pushes this pushbutton to display the STATUS page on the lower SD. The pushbutton remains lit, as long as the SD displays the STS page. If the system has no status messages, the status page displays "NORMAL" for five seconds.

The pilot can clear the STATUS page by pushing the CLR pushbutton, or by pushing the STS pushbutton a second time.

When only one ECAM display is on :

- It displays the STATUS page only when the pilot pushes the STATUS pushbutton and holds it. He can display the next STATUS page, if any, by releasing the pushbutton and pushing it again (before two seconds have elapsed). The new page then appears after a short delay.
- The pilot can keep the STS pushbutton pressed to display the STATUS page for a maximum of 3 minutes, after which the ECAM automatically displays the engine/warning page.

⑤ CLR pushbutton

This pushbutton remains lit as long as the E/WD is displaying a warning, or caution message, or a status message on the SD.

If it is lit, pressing it changes the ECAM display.

⑥ ALL pushbutton

When this pushbutton is pressed and held down, the SD successively displays all the system pages at two-second intervals.

If the ECAM control panel fails, the pilot can use this pushbutton to page through the system pages until he comes to the one he wants to look at. He then releases the pushbutton to select that page.

 AIRBUS TRAINING A330 SIMULATOR FLIGHT CREW OPERATING MANUAL	INDICATING/RECORDING SYSTEMS	1.31.30	P 3
	ECAM CONTROLS	SEQ 001	REV 12

⑦ EMER CANC pb

This pushbutton affects the following :

- Warnings :
 - Cancel (stop) an aural warning, for as long as the failure condition continues.
 - Extinguishes the MASTER WARNINGS lights.
 - Does not affect the ECAM message display.
 - Cautions :
 - Cancel any present caution (single chime, MASTER CAUTION lights, ECAM message) for the rest of the flight.
 - Automatically calls up the STATUS page, which displays “CANCELLED CAUTION” and the title of the failure that is inhibited.
- The inhibition is automatically suppressed when Flight Phase 1 is initiated. The pilot may restore it manually by pressing the RECALL pushbutton for more than three seconds.

R *Note : This pushbutton should only be used to suppress spurious MASTER*
 R *CAUTIONS.*

⑧ TO CONFIG pb

This pushbutton simulates the application of takeoff power. This is a test that triggers a warning, if the aircraft is not in takeoff configuration. (See 1.31.15).
 If the configuration is correct, the E/WD displays the “TO CONFIG NORMAL” message in the TO MEMO section.

Note : If the ECAM control panel fails, the CLR, RCL, STS, EMER CANC, and ALL pushbuttons remain operative, because their contacts are directly wired to the flight warning and display management computers.

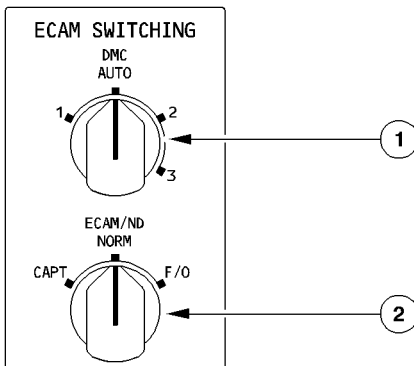
ECAM SWITCHING PANELON MAIN INSTRUMENT PANEL

GFC5-01-3130-004-A001AA

R ① DMC selector switch

- AUTO** : DMC 3 supplies data to both ECAM DUs
 In case of DMC 3 failure, the DMC 1 automatically takes over.
- 1** : DMC 1 replaces DMC 3
2 : DMC 2 replaces DMC 3
3 : DMC 3 supplies data to both ECAM DUs

Note : If a DMC fails, each of its associated DUs displays a diagonal line.

R ② ECAM/ND transfer selector switch

R Transfers the system/status display to either the captain's or the first officer's NDU.

Note : If both ECAM DUs (E/WD and SD) fail, the flight crew can use this switch to transfer the E/W display to either navigation display.



ATTENTION GETTERS

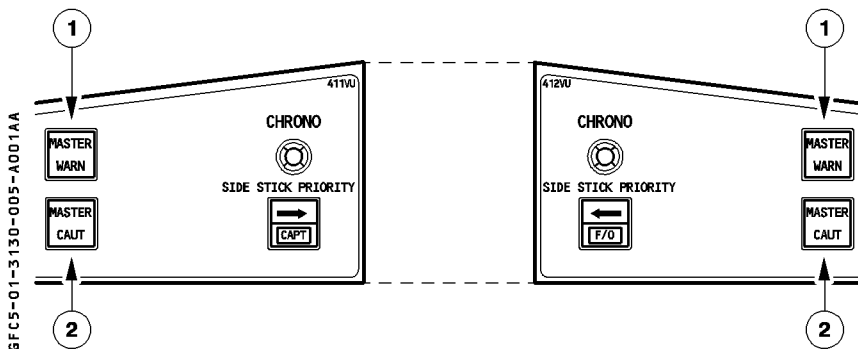

① MASTER WARN lights

- Flash red for level 3 warning.
- Accompanied by an aural warning (continuous repetitive chime, specific sounds or synthetic voice).

② MASTER CAUT lights

- Light up steady amber for a level 2 caution.
- Accompanied by a single chime.

These lights go out when :

- One pilot presses the light (except for some red warnings, such as the overspeed and stall warnings).
- The warning/caution situation is over.
- The pilot presses the CLR pushbutton on the ECAM control panel (except for some red warnings, such as the overspeed and stall warnings).
- The pilot presses the EMER CANC pushbutton on the ECAM control panel.

The aural warnings cease when :

- One pilot presses the MASTER WARN light (except for some red warnings, such as the overspeed and stall warnings).
- The warning situation is over.
- The pilot presses the EMER CANC pushbutton on the ECAM control panel.



GENERAL

The Primary Flight Display (PFD) provides the following information to the flight crew :

- Attitude and Guidance
- Airspeed
- Altitude (baro and radio) and Vertical Speed
- Heading and Track
- FMGS modes (Flight Mode Annunciator)
- Vertical and Lateral Deviations
- Radio navigation information (ILS, DME).

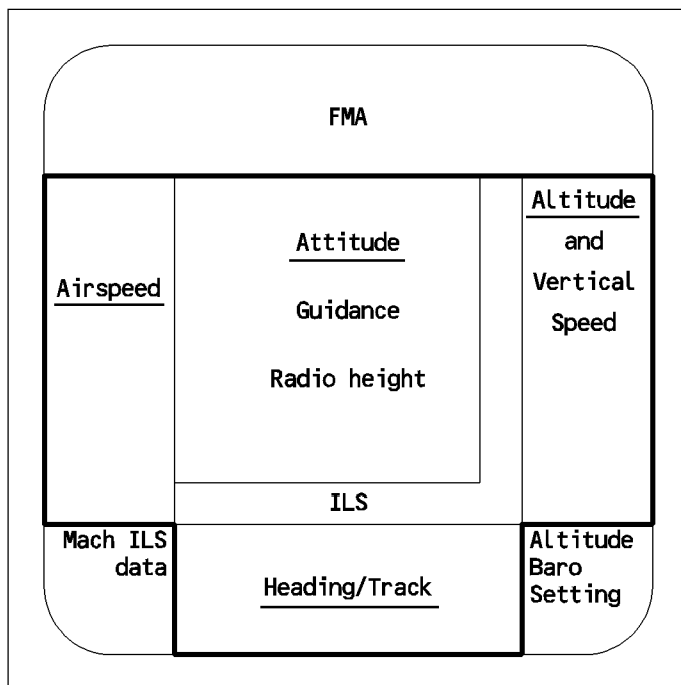

6FC5-01-3140-001-A001AA

The FWC monitors such main parameters as : Attitude, heading, and altitude. Also refer to the "FLAGS AND MESSAGES DISPLAYED ON PFD" Chapter.

Note : A grey background appears on the speed, the heading vertical speed, and the altitude speed scales of the PFD. If the Primary Flight Display (PFD) Unit temperature exceeds a defined threshold, the grey background disappears, in order to limit power consumption and prevent a DU overheat. Any additional increase in temperature will lead to a complete cut off of the power supply to this display unit.

 R
 R

SPECIFIC GROUND INDICATIONS

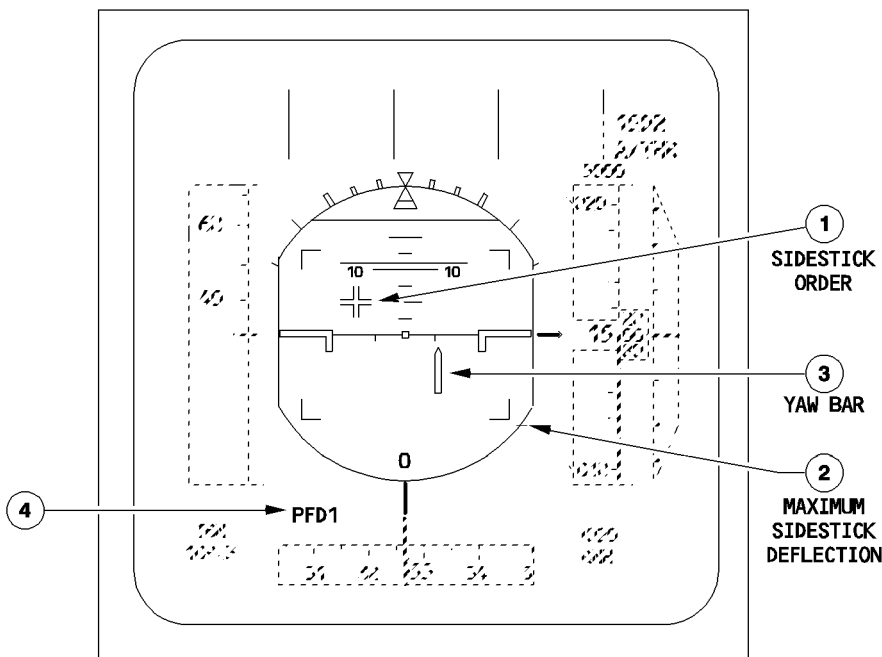

6FC5-01-3140-002-A001AB

① Sidestick order indication (white)

This is displayed, as soon as one engine is started. It indicates the total of the pilot's and copilot's sidestick orders (shown here as left wing down, pitch up).

② Max Sidestick Deflection (white)

This is displayed, as soon as one engine is started.

③ Ground Roll Guidance Command Bar (green)

This symbol is displayed when the aircraft is on the ground, or below 30 feet radio altitude provided a localizer signal is available. It shows the flight director yaw orders to keep the runway center line.

④ PFD 1 (2 or 3) message (magenta)

The display indicates which DMC drives the PFD. It only appears during test on ground.

R
R



ATTITUDE DATA

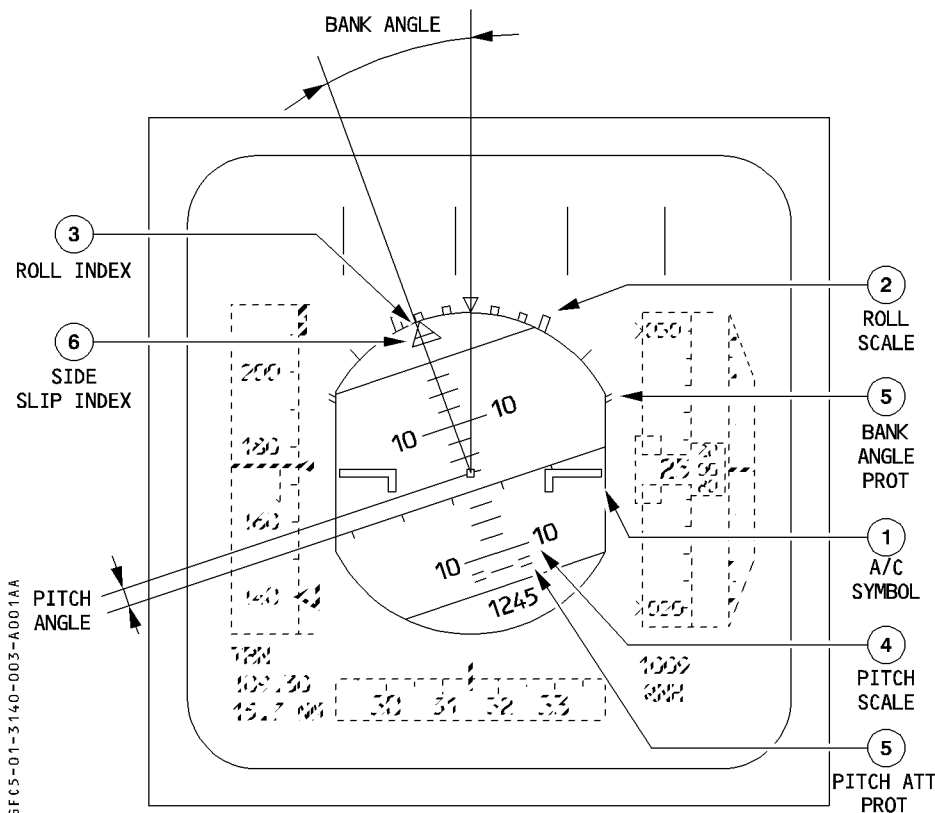

① Fixed Aircraft Symbol

This symbol is black, outlined in yellow.

② Roll Scale

This scale is in white, and has markers at 0, 10, 20, 30, and 45 degrees of bank.

③ Roll Index (yellow)

This pointer indicates the bank angle. When the bank angle exceeds 45° , all the PFD symbols, except those for attitude, speed, heading, altitude, and vertical speed, disappear. The display returns to normal when the bank angle decreases below 40° .

④ Pitch Scale (white)

This scale has markers every ten degrees between 80° nose up and 80° nose down (every 2.5° between 10° nose down and 30° nose up). When pitch angle exceeds 25° nose up or 13° nose down, all the PFD displays except attitude, speed, speed trend, heading, altitude, and vertical speed disappear. Beyond 30°, large red arrowheads indicate that the attitude has become excessive and show the direction to move the nose in order to reduce it. The display returns to normal when pitch angle becomes less than 22° nose up or 10° nose down.

⑤ Flight Control Protection Symbols

The display shows these symbols in green :

- on the roll scale at $\pm 67^\circ$ to mark the bank angle limits
- on the pitch scale at 15° nose down or 30° nose up to mark the pitch limits.

An amber \times replaces these symbols if the corresponding protection is lost. (Refer to 1.27.30)

⑥ Sideslip Index (yellow)

This trapezoidal index moves beneath the roll index. On the ground it represents the lateral acceleration of the aircraft : in flight it shows sideslip (as furnished by ADIRS). One centimeter of displacement indicates 0.2g. The sideslip index is against its stop at 0.3g.

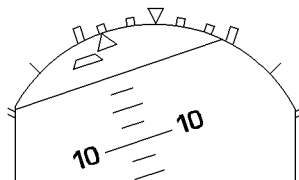

In case of engine failure at takeoff or go-around, the sideslip index changes from yellow to blue.

Note : The sideslip target is blue if :

- CONF 1, 2, or 3 is selected, and
- any ENG EPR > 1.3, and
- difference between ENG EPR > 0.25.

In this case the sideslip index is called β target.

When this index is centered with the roll index, the sideslip equals the sideslip target for optimum aircraft performance.

**AIRSPEED**

R

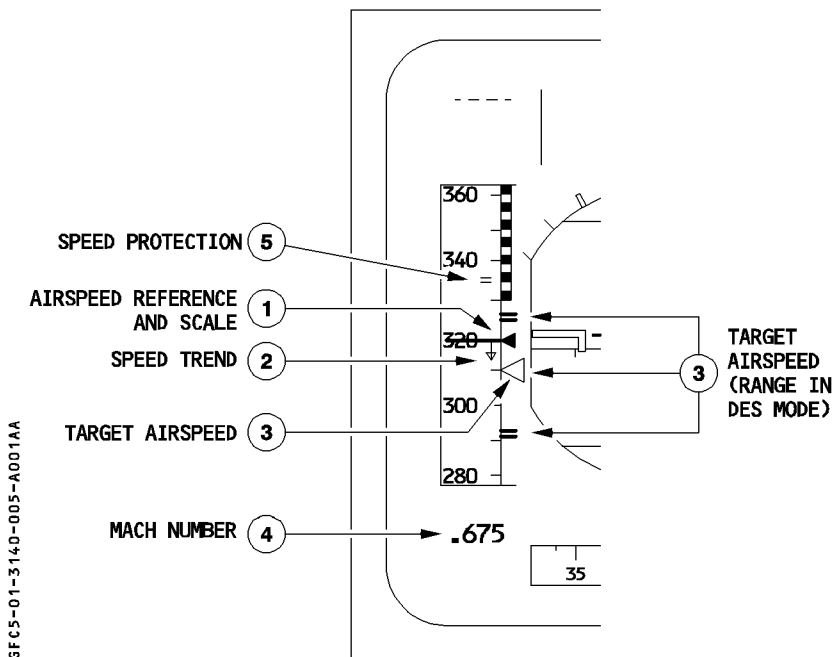
**① Actual Airspeed Reference Line and Scale**

A white scale on a grey background moves in front of a fixed yellow reference line next to a yellow triangle to show airspeed. The minimum airspeed indication is 30 knots.

② Speed Trend (yellow)

This pointer starts at the speed symbol. The tip shows the speed the aircraft will reach in 10 seconds if its acceleration remains constant. The pointer appears only when it is greater than 2 knots and disappears when it is less than 1 knot. It also disappears if the FMGCs fail.



③ Target Airspeed (magenta or blue)

This symbol gives the target airspeed or the airspeed corresponding to the target Mach number.

The target airspeed is the airspeed computed by FMGC in managed speed mode (magenta) or entered manually on the FCU for selected speed mode (blue).

When the target speed is off the speed scale, its value is displayed as numbers below or above the speed scale.

④ Mach Number (green)

This is displayed when it is greater than 0.5 and the LS pushbutton is not selected on the EFIS control panel.

⑤ Speed Protection (green)

This symbol indicates the speed ($VMO + 4$ kt or $MMO + 0.006$) at which overspeed warning will occur. This symbol is not displayed in pitch alternate or direct law because the protection is not available. (Refer to 1.27.30).

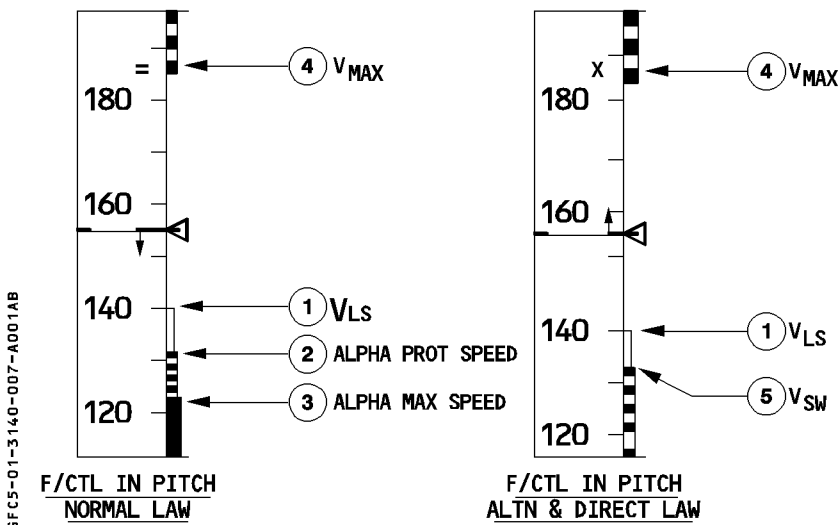

① Minimum Selectable Speed (VLS)

The top of the amber strip along the speed scale indicates this speed. It represents the lowest selectable speed providing an appropriate margin to the stall speed. (Refer to 3.04.10)

VLS information is inhibited from touchdown until 1 second after liftoff.

② Alpha Protection Speed

The top of a black and amber strip along the speed scale indicates this speed. It represents the speed corresponding to the angle of attack at which alpha protection becomes active (Refer to 1.27.20).

It is displayed when in pitch normal law.

③ Alpha Max Speed

The top of a red strip along the speed scale indicates this speed. It represents the speed corresponding to the maximum angle of attack that the aircraft can attain in pitch normal law (Refer to 1.27.20).

It is displayed when in pitch normal law.

**④** VMAX

The lower end of a red and black strip along the speed scale defines this speed.

It is the lowest of the following :

- VMO or the speed corresponding to MMO
- VLE
- VFE

(Refer to 3.04.10)

⑤ Stall Warning Speed (VSW)

The top of a red and black strip along the speed scale defines this speed.

It is the speed corresponding to the stall warning. (Refer to 1.27.20).

VSW information is inhibited from touchdown until 5 seconds after liftoff.

It is displayed when operating in pitch alternate or pitch direct law.

R

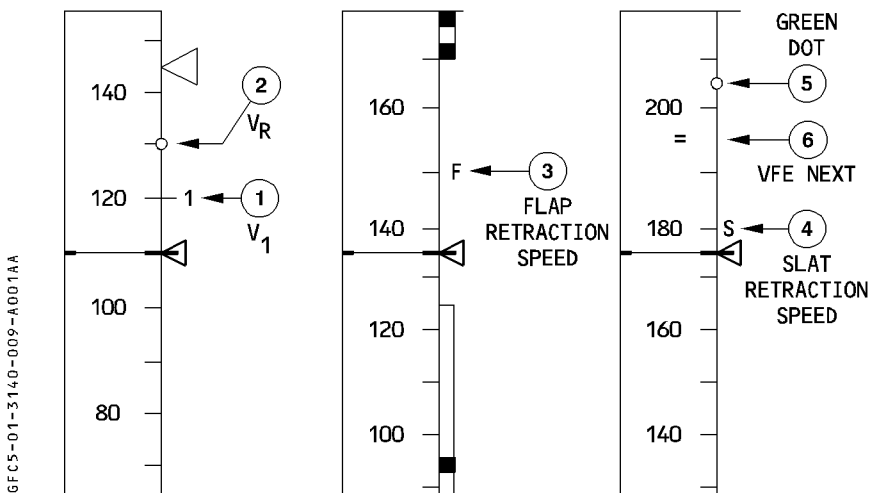

① Decision Speed : (V1)

This is a blue symbol (numeric) that the crew manually inserts via the MCDU. When it is off the scale, the upper part of the scale shows it in numbers. It disappears after liftoff. (Refer to 3.04.10)

② Rotation speed : (VR)

This is a blue circle and corresponds to the value that the crew manually inserts via the MCDU. It appears during takeoff, while on ground.

*Note : V2 is represented by the target speed index during takeoff.
V2 is manually inserted by the crew via the MCDU.*

③ Minimum Flap Retraction Speed

This is a green symbol (letter F). It appears when the flap selector is in Position 2 or 3. (Refer to 3.04.10)

④ Minimum Slat Retraction Speed

It is represented by a green symbol (letter S). It appears when the flap selector is in Position 1. (Refer to 3.04.10)



⑤ Green Dot (Engine-out operating speed in clean configuration)

This green dot appears when the aircraft is flying in the clean configuration. It shows the speed corresponding to the best lift-to-drag ratio.

⑥ VFE NEXT

This symbol, an amber =, shows the VFE corresponding to the next flap lever position. It appears when the aircraft altitude is below 20000 feet. (Refer to 3.04.10)



ALTITUDE

R

6FC5-01-3140-011-A100AA

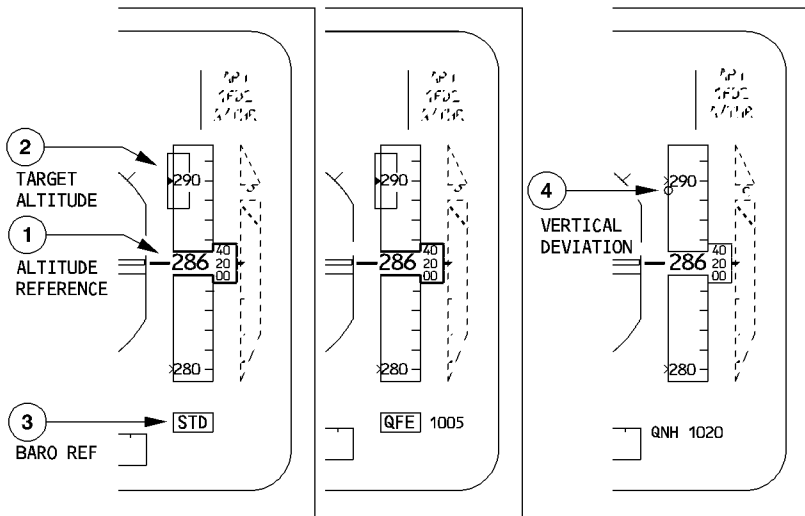

① Altitude Indication

Given on a grey-colored background, both in analog and digital presentation, with the white moving scale and the green digital readout in the altitude window.

Small white marks are positioned on the scale against the round values (e.g. 280, 290...). "NEG" appears in the window in white for negative altitudes.

The altitude window changes from yellow to amber, if the aircraft deviates from the FCU-selected altitude/flight level (refer to altitude alert system).

On any approach for which an MDA (MDH) is entered in the FMGS, the altitude numbers change from green to amber, when the aircraft goes below the MDA (MDH).

② Target Altitude or Selected Flight Level Symbol (magenta or blue)

This symbol shows the FCU-selected altitude (if QNH, if installed, baro reference is selected), or the selected flight level (if STD baro reference is selected), or selected height (if QFE baro reference is selected).

When the FMGC operates in the vertical managed mode, this symbol is in magenta, if it represents a flight plan altitude constraint that the FMGC will follow.

If the target altitude or flight level is on the scale, the symbol is displayed and the numerical value appears inside the symbol.

If it is off the scale, the symbol is not displayed, and the numerical value appears above or under the scale.

③ Barometric Reference

The display shows "STD" or it shows "QNH" or "QFE" and the numerical setting in hectoPascals or inches of mercury.

It pulses when the selection made by the pilot is not correct (STD not selected above transition altitude in climb or STD still selected in approach below transition level or 2500 feet radio height if transition level is not available).

④ Vertical Deviation (magenta)

This symbol appears next to the altitude corresponding to the theoretical vertical profile computed by the FMGC. It is displayed from the top of descent down to the MAP altitude.

The pilot can read the VDEV directly from the altitude scale. The range is ± 500 feet. When the VDEV value exceeds ± 500 feet, the symbol stays at the range limit and the PROG page displays the exact value.

METRIC ALTITUDE INDICATION

If metric reference is selected on the FCU two additional symbols are displayed on PFD.

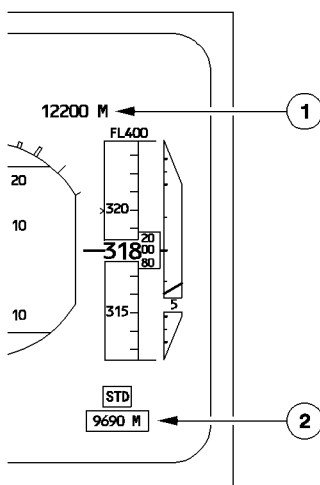

① Target altitude or selected flight level (magenta or blue)

The display shows the selected altitude value in meters.

② Altitude indication (green)

The display shows the actual aircraft altitude value in meters.

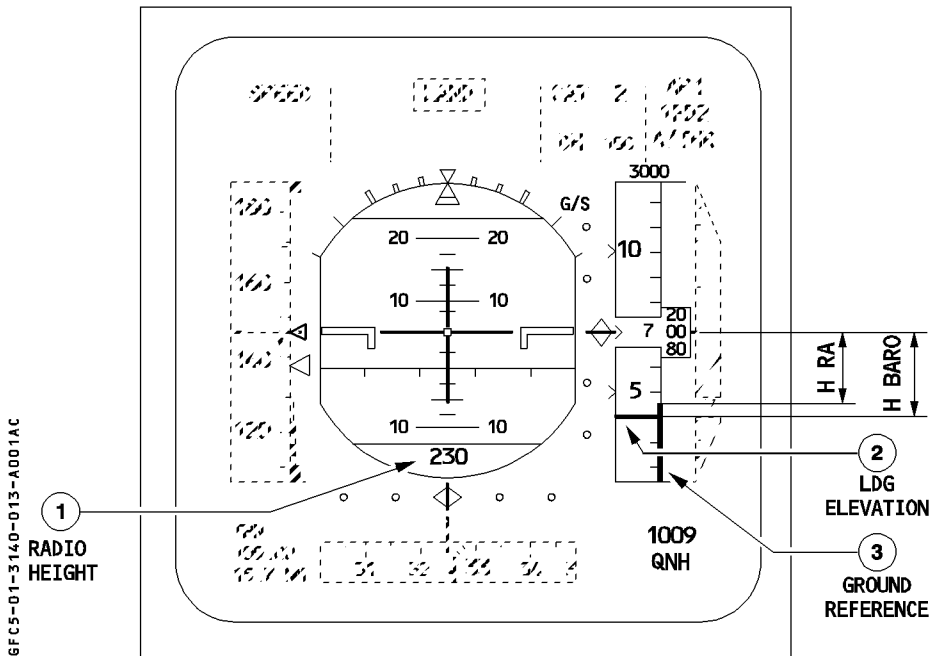

① Radio Height

This quantity appears when it is less than 2500 feet.

- If a DH has been entered, the radio height appears :
 - in green when $DH + 100 \text{ feet} < RA < 2500 \text{ feet}$
 - in amber when $RA < DH + 100 \text{ feet}$

If "NO" is entered as the DH on the MCDU APPROACH page, 0 feet becomes a default value.

When the aircraft reaches the decision height selected on the MCDU, DH letters flash amber for three seconds, then stay in amber above the radio height indication.

- If no DH has been entered or if both FMGCs fail, the radio height appears :
 - in green when $400 \text{ feet} < RA < 2500 \text{ feet}$
 - in amber when $RA \leq 400 \text{ feet}$

The radio altitude indication changes every 10 feet down to 50 feet, then every 5 feet down to 10 feet, then every foot.



② Landing Elevation (blue)

The horizontal bar on the altitude scale shows the landing elevation at the flight-planned destination.

It is displayed :

- during flight phases 7 and 8 and
- if the QNH reference mode is selected.

③ Ground reference

A red ribbon on the right of the altitude scale represents the field elevation. This ribbon, which is driven by the radio altimeter signal, is displayed below 570 feet.

It moves up, as does the lower line of the attitude sphere, with the altitude scale as the aircraft descends. When the aircraft has touched down, the top of this ribbon is at the middle of the altitude window.

VERTICAL SPEED

- R The displayed vertical speed information is normally based on both inertial and barometric data. If inertial data is not available, it is automatically replaced by barometric information.
- R In this case, the window around the numerical value becomes amber.

GFC5-01-3140-015-A001AB

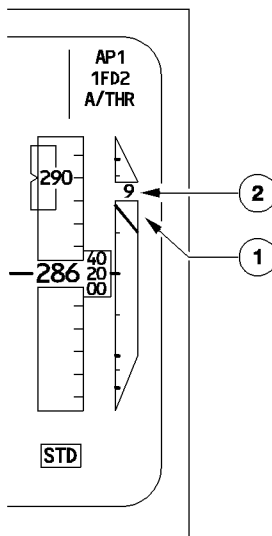
**① Analog pointer**

This pointer, which is normally green, points to a white vertical speed scale displayed on a grey background and graduated at intervals of 500 feet/minute.

If the V / S is greater than 6000 feet/minute, the pointer stays at the end of the scale.

② Digital indication

This number, normally green, is the vertical speed in hundreds of feet per minute. It disappears, if the vertical speed is less than 200 feet/minute.

The analog pointer and the digital indication become amber, if :

- V / S is greater than 6000 feet/minute, (climb or descent)
- V / S is greater than 2000 feet/minute, during descent when 1000 feet < RA < 2500 feet, or
- V / S is greater than 1200 feet/minute, during descent and RA < 1000 feet

Note : For TCAS, refer to 1.34.80.

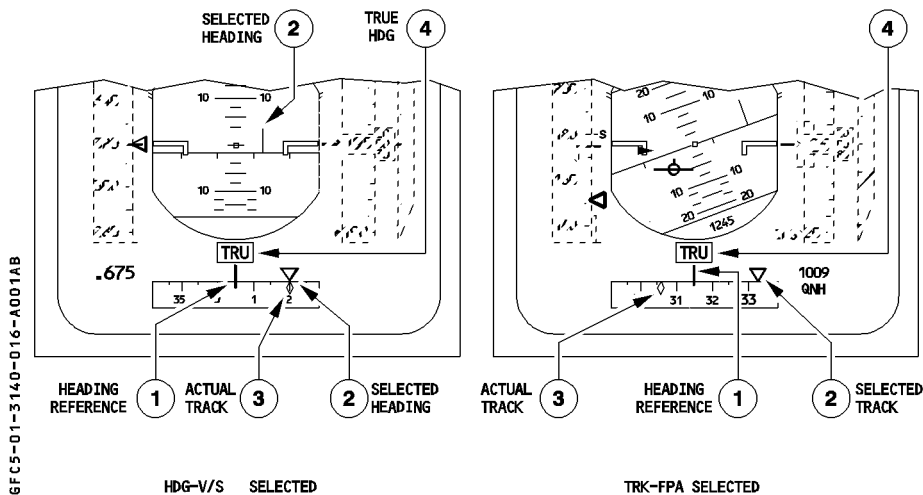
HEADING**①** Heading Reference Line and Scale

A white scale on a gray background moves in front of a fixed yellow reference line to show the actual magnetic heading.

② Selected Heading or Track Index (blue)

The pointer indicates the heading or track selected on the FCU HDG-TRK counter. The index is replaced by digits on the right or on the left side of the scale when the selected value is off the scale. If the FD pushbutton switch is OFF a second heading or track symbol appears on the horizon line and markers are displayed every 10°.

③ Actual Track Symbol

This symbol is a small green diamond.



④ True heading (blue)

At high latitude, above 82.5° North or 60.5° South (or entering the north, magnetic polar region latitude 73.5° N and longitude between 117.5° W and 92.5° W) the ADIRUs replace magnetic heading by true heading on EFIS and DDRMI.

When the aircraft is in close proximity to these regions (latitude above 82° North or 60° South or approaching the north polar region : 73° N and longitude between 90° W and 120° W) the ADIRU will trigger a message on ND "SELECT TRUE REF" requesting to change north reference.

In true heading configuration at slats extension "TRU" with flash for 9 seconds then remains steady.

Location of TRU indication is shifted to right hand side of the scale when the ILS localizer deviation scale is displayed.

FLIGHT PATH VECTOR

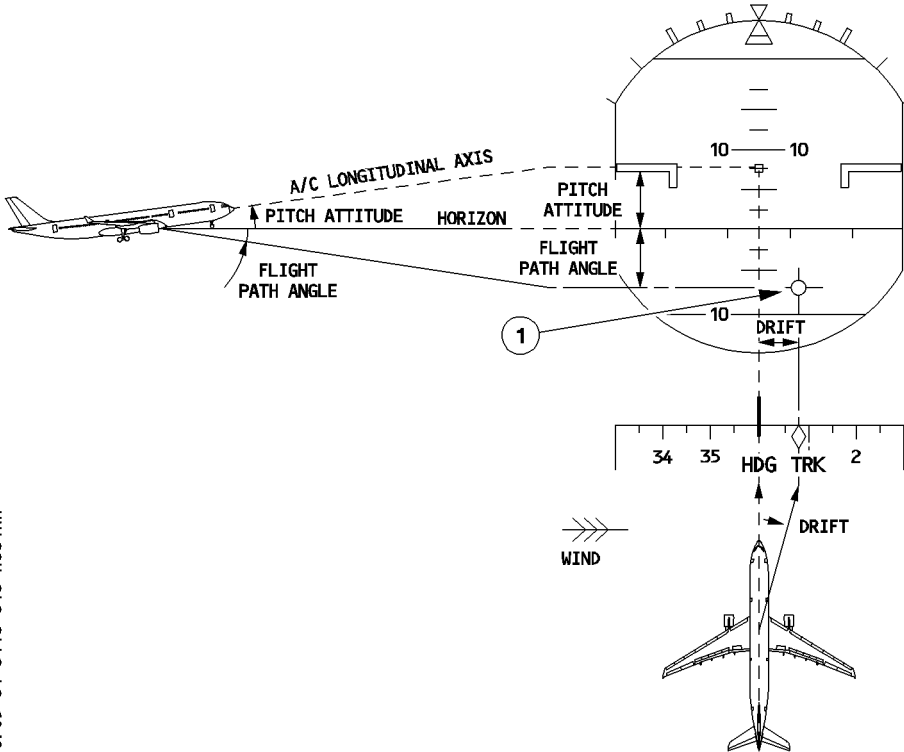

GFC5-01-3140-018-A001AA

① Flight Path Vector (FPV)

This symbol appears when the pilot selects TRK/FPA on the FCU.

The flight path vector represents the lateral and vertical trajectory of the aircraft with respect to the ground.

- On the lateral scale it indicates the aircraft's track.
- On the vertical scale it indicates the aircraft's flight path angle.

Example : The aircraft flies a track of 009 (heading 360°, wind from west) and descends with a flight path angle of -7.5° .

GUIDANCE

Two completely different flight director modes are available, each with its own characteristic symbols. The symbol displayed corresponds to the basic operating reference the pilot has selected. – either HDG V/S or TRK FPA.

In normal operation PFD1 displays FD1 orders.

If FD1 fails, PFD1 automatically displays FD2 orders, and on the PFD1 the FD2 indication in the right column of the FMA flashes for a few seconds.

The same applies for FD2 orders normally displayed on PFD2.

IF THE CREW HAS SELECTED HDG V/S TO BE THE BASIC REFERENCE :

The PFD displays pitch and roll bars in green. They automatically move out of view at touchdown in ROLL OUT mode.

They flash for 10 seconds and then remain steady in the following conditions :

- reversion to the HDG V/S basic mode (manually or automatic)
- change of selected flight level when the autopilot is already engaged in ALT CAPTURE mode
- loss of LOC or G/S in LAND mode or loss of LAND mode
- at the first AP or FD engagement

The PFD displays a yaw bar in green below 30 feet radio altitude if a localizer signal is available:

- R – during takeoff (in RWY mode)
- upon landing (in FLARE and ROLL OUT mode).

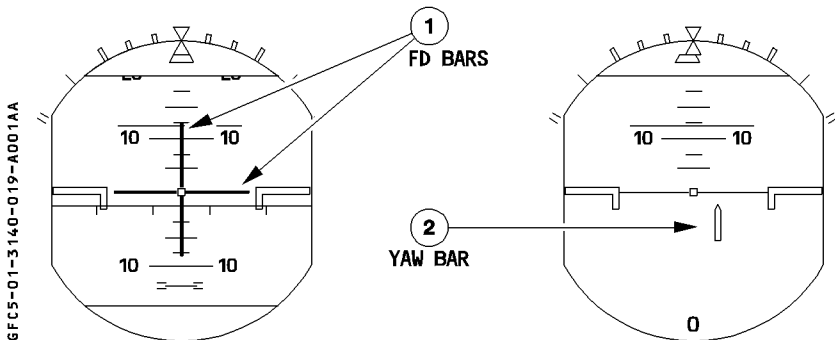

① FD Crossed Bars (green)

② Yaw Bar (green)

THE CREW HAS SELECTED TRK FPA AS THE BASIC REFERENCE :

An inertial flight path vector defines the aircraft's horizontal and vertical track, taking wind effect into account.

An associated flight path director symbol guides the flight crew onto the vertical and horizontal flight path targets.

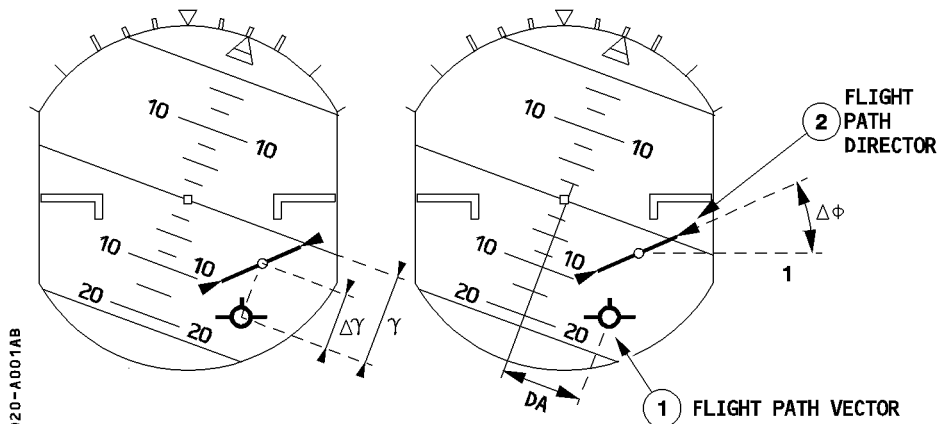

GFC5-01-3140-020-A001AB

γ REPRESENTS THE FLIGHT PATH ANGLE

DA REPRESENTS THE DRIFT ANGLE

$\Delta\gamma$ REPRESENTS THE DIFFERENCE BETWEEN THE ORDERED FLIGHT PATH ANGLE AND THE ACTUAL ONE

$\Delta\phi$ REPRESENTS THE DIFFERENCE BETWEEN THE ORDERED ROLL ANGLE AND THE ACTUAL ONE

① Flight Path Vector (green)

② Flight Path Director (green)

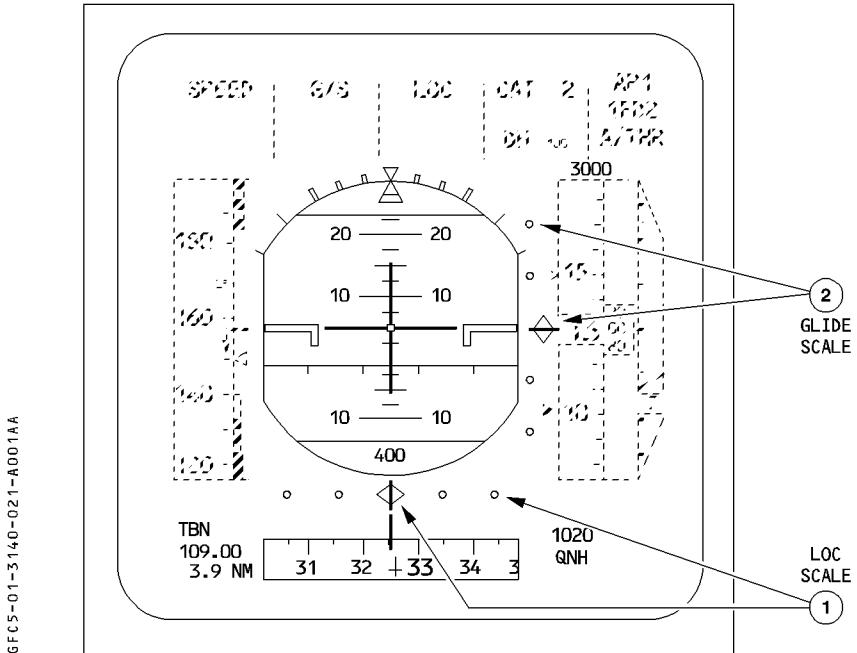
TRAJECTORY DEVIATION**ILS APPROACH**

- ① Localizer Deviation Scale and Index
- ② Glide Slope Deviation Scale and Index

Deviation scales appear as soon as the flight crew pushes an LS pushbutton switch on the EFIS control panel. Deviation indexes appear when the glide slope and localizer signals are valid if deviation scales are displayed.

When a deviation index is out of the displayed range, only half a symbol appears at the end of the scale.

The LOC scale flashes and continues to flash if the deviation exceeds 1/4 dot for two seconds (above 15 feet RA). The glide scale flashes and continues to flash if the deviation exceeds one dot for two seconds (above 100 feet RA).

“LOC” and the glide scale half index symbols flash and continue to flash when the deviation exceeds two dots for two seconds.

R One dot represents a deviation of $\pm 0.8^\circ$ on the localizer scale and $\pm 0.4^\circ$ on the glide
 R slope scale.

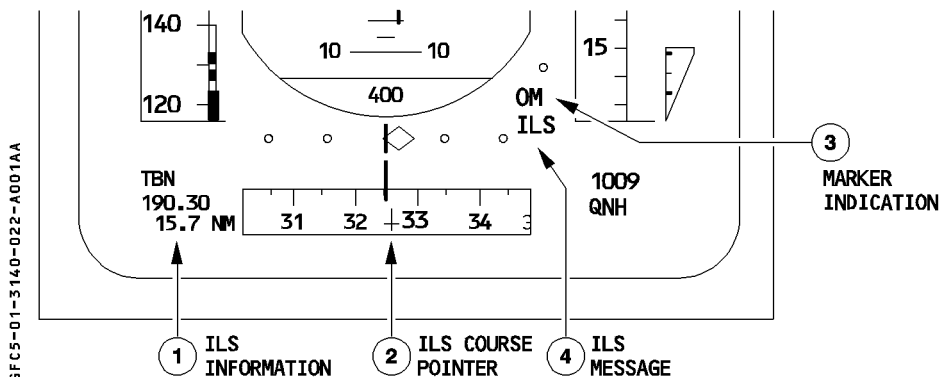

① ILS information (magenta)

The following information appears on the PFD when the crew has selected an ILS frequency and course and pushed the LS pushbutton :

- ILS identification as decoded by the ILS receiver
- ILS frequency
- DME distance if the ILS has a DME

② ILS course Pointer (magenta)

This pointer appears on the PFD when the crew has selected an ILS frequency and course and pushed the LS pushbutton.

It is a dagger-shaped symbol on the heading scale.

The ILS course (numerical) appears in magenta on the right or the left side of the scale when it is outside the displayed range of headings.

③ Marker Indications

OM appears in blue when aircraft flies over the outer marker

MM appears in amber when it flies over the middle marker

AWY appears in white when it flies over an airways marker beacon or the ILS inner marker.

④ ILS Message

This flashes amber when the APPR mode is armed and the ILS display is not selected.



NON PRECISION APPROACH

R

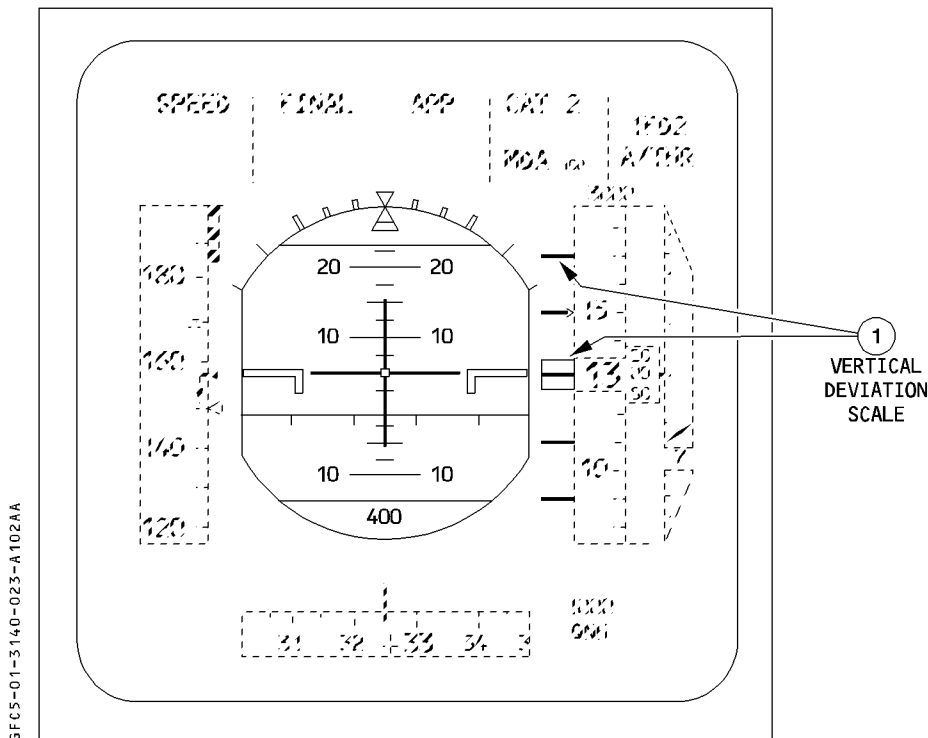

① Vertical Deviation Scale and Index

R The vertical deviation scale and index appear when in approach phase and, when either
 R the FINAL APP mode is armed/engaged, or a non-LS approach has been entered. They
 R are displayed in the approach or go-around phase, until the MDA has been reached, or
 R the MAP or the runway has been sequenced. They give the vertical deviation with
 R respect to the trajectory defined by the FMGC.
 Each index scale graduation represents 100 feet. The range limit is ± 200 feet.

R Note : If the LS pushbutton is pressed, glide deviation has priority over vertical deviation
 R information. As long as V/DEV display conditions are met, and the LS pushbutton
 R is selected, an amber V/DEV message flashes above the glide scale.

RIISING RUNWAY SYMBOL

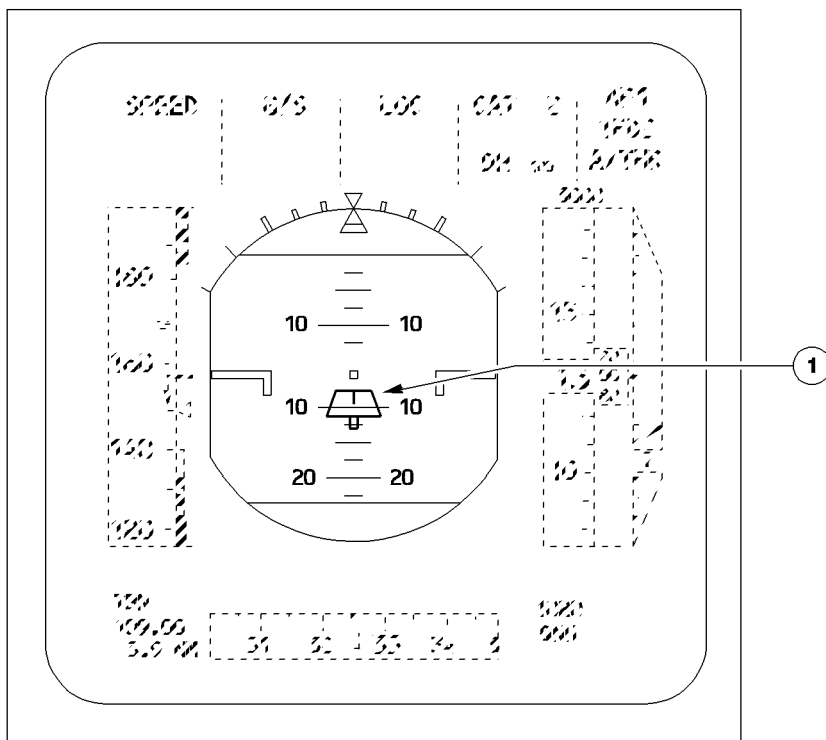

6FC5-01-3140-024-A100AB

① Rising Runway Symbol (magenta)

If :

- The localizer signal is valid,
- The radio altitude is available, and
- The yaw bar is not displayed,

at 200 feet RA the runway symbol starts from the bottom of the pitch scale. Its vertical deviation is driven by the radio altitude and its lateral deviation by the localizer.

Note : When the rising runway option is installed, the lower line of the attitude sphere does not move for ground reference.



FLIGHT MODE ANNUNCIATOR

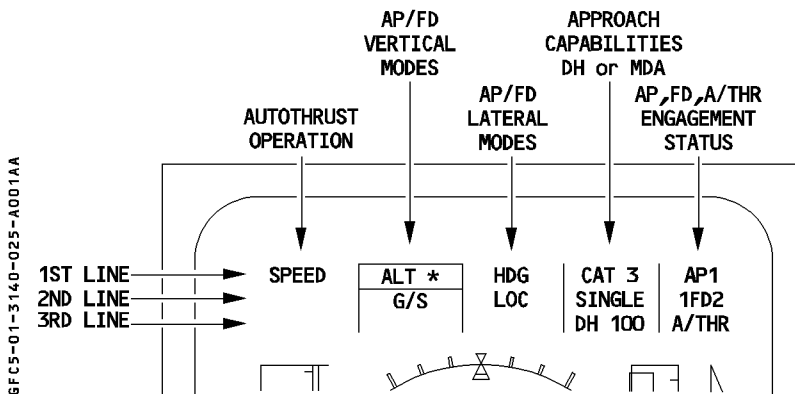

For a detailed discussion of legends and messages that may appear during FMGS operations, see autoflight chapter (Refer to 1.22.30).



LEFT INTENTIONALLY BLANK



ALTITUDE ALERT

The FWC generates an altitude warning (C chord sound and altitude window of PFD pulsing yellow or flashing amber) when the aircraft approaches a preselected altitude or flight level or when it deviates from its selected altitude or flight level.

This warning results from a comparison between the altitude (ADIRS) and the preselected altitude displayed on FCU.

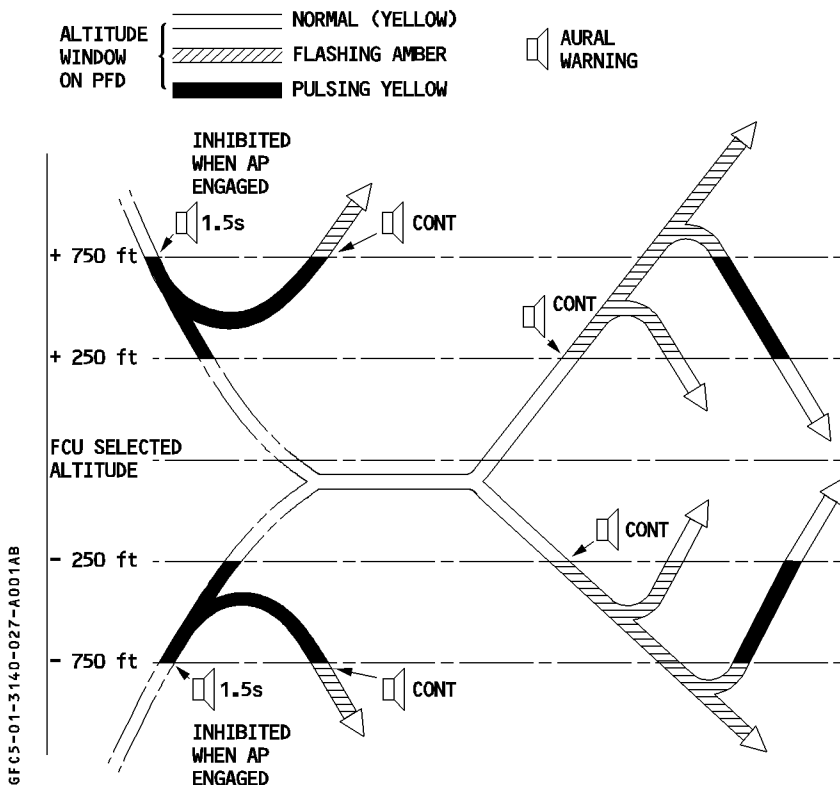

- The selection of a new altitude cancels the continuous C chord, as does the crew's pushing the EMER CANC pushbutton of the ECAM control panel or the pressing either MASTER WARN pushbutton.
- The selection of a new altitude stops the flashing of the altitude window.
- The altitude alert is inhibited :
 - when the slats are out with landing gear selected down, or
 - in approach after the aircraft captures the glide slope, or
 - when the landing gear is locked down.

FLAGS AND MESSAGES DISPLAYED ON PFD

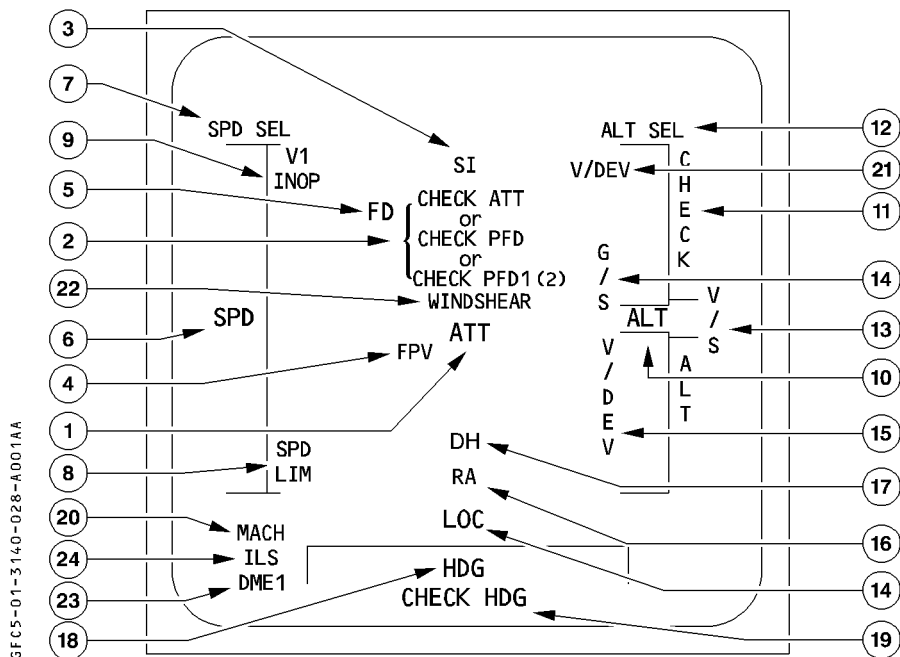

① ATT flag (red)

If the PFD loses all attitude data, its entire sphere is cleared to display the ATT flag.

② CHECK ATT or CHECK PFD or CHECK PFD1 (or 2) flag (amber)

"CHECK ATT" appears when there is a disagreement (of a least 5°) in the attitude information displayed by the two PFDs. The CHECK ATT flag appears on both PFDs, and a caution appears on the ECAM.

"CHECK PFD" appears when the DMC detects a disagreement between the two PFDs. The CHECK PFD flag appears on both PFDs.

"CHECK PFD 1(2)" appears when the DMC detects a disagreement between its own computation and its displayed information. The CHECK PFD 1(2) flag appears on the relevant PFD.

 AIRBUS TRAINING A330 SIMULATOR FLIGHT CREW OPERATING MANUAL	INDICATING/RECORDING SYSTEMS	1.31.40	P 29
	INDICATIONS ON PFD	SEQ 001	REV 18

③ SI flag (red)

If the sideslip information is lost, the index disappears and a red SI flag appears.

④ FPV flag (red)

In TRK FPA mode, when the drift angle or flight path angle is not valid, an FPV flag appears.

⑤ FD flag (red)

If both FMGCs fail, or if both FDs are disengaged and the FD pushbutton is on and the attitude is valid, a red FD flag appears.

⑥ SPD flag (red)

If speed information fails, a SPD flag replaces the speed scale.

⑦ SPD SEL flag (red)

If selected speed information fails, a SPD SEL flag appears.

⑧ SPD LIM flag (red)

This flag appears when both FMGCs (flight envelope part) are inoperative, or in case of SFCC dual flap/slat channel failure.

In this case, the following PFD information is lost : VLS, S, F, Green Dot, Vtrend, Vmax, VFE next, VSW.

⑨ V1 INOP flag (red)

When the V1 signal is not valid, a V1 INOP flag replaces the digital value.

⑩ ALT flag (red)

If the altitude information fails, the ALT flag replaces the altitude scale.

⑪ CHECK ALT flag (amber)

The CHECK ALT flag appears, as does an ECAM caution, if the disagree between the two PFDs altitude indications is greater than 250 feet when QNH is selected, or 500 feet when STD is selected.

R The caution and the flag disappear, when the pilot's and the copilot's barometer references disagree.

**12** ALT SEL flag (red)

If the selected altitude information fails, an ALT SEL flag appears.

13 V/S flag (red)

If the vertical speed information fails, the V/S flag replaces the vertical speed scale.

14 LOC and G/S flags (red)

If the localizer or glideslope receiver fails, a LOC or G/S flag appears on the deviation scale.

15 V/DEV flag (red)

R If the vertical deviation information fails and the LS pushbutton is not pressed, a V/DEV flag replaces the V/DEV scale.

16 RA flag (red)

If both radio altimeters fail, this flag appears in place of the radio height indication when the aircraft altitude is below the transition altitude. The ground reference indication (red ribbon) will disappear.

17 DH flag (amber)

A DH flag appears, when the aircraft reaches the selected DH.

18 HDG flag (red)

If the heading information fails, the HDG flag replaces the heading scale.

19 CHECK HDG flag (amber)

The CHECK HDG flag appears, as does an ECAM caution, if there is a discrepancy (5°) between pilots's and copilot's heading indications.

20 MACH flag (red)

This flag appears, if the Mach data fails.

21 V/DEV (amber)

At the top of the glide scale, this message flashes when in approach phase and, either FINAL mode is armed/engaged, or a non-LS approach has been selected, and the LS pushbutton is selected.



② WINDSHEAR (red) or W/S AHEAD (red or amber) warnings

- WINDSHEAR** : Reactive windshear warning. Displayed, when the FMGC detects windshear.
The detection function is available at :
– Takeoff, from 3 seconds after lift-off, up to 1300 feet RA,
– Landing, from 1300 feet RA, down to 50 feet RA,
provided the aircraft is not in clean configuration.
It remains displayed at least 15 seconds after windshear detection.
Associated with an aural “WINDSHEAR” warning which is repeated 3 times.
- W/S AHEAD** : Predictive windshear warning. Displayed, when a windshear alert is generated by the predictive windshear system below 1500 feet RA.
The color depends on the alert level.
Three different alert levels exist, depending on windshear strength and proximity :

Alert Level	Aural Warning	PFD	ND (refer to 1.31.45)
Warning (Landing)	«GO AROUND WINDSHEAR AHEAD»	W/S AHEAD (red)	Windshear icon
Warning (Takeoff)	«WINDSHEAR AHEAD» (twice)	W/S AHEAD (red)	Windshear icon
Caution	«MONITOR RADAR DISPLAY»	W/S AHEAD (amber)	Windshear icon
Advisory	Nil	Nil	Windshear icon

- Note* : 1. All flags except SI, V1 INOP, DME 1 (which are steady) flash for 9 seconds then are steady.
DH flag flashes for 3 seconds then is steady.
2. For TCAS, Refer to 1.34.80.

③ DME 1 flag (red)

When DME distance is not available, a DME 1 (on PFD 1) or DME 2 (on PFD 2) replaces the DME distance indication.

R ④ ILS flag (red)

- R If an ILS frequency is not available, or if either the LOC or G/S signals fail, an ILS flag
R replaces the ILS frequency indication.



GENERAL

There are six different displays (five display navigation information, and one displays primary engine parameters) :

- ROSE LS
- ROSE VOR
- ROSE NAV
- ARC
- PLAN
- ENG (stand by page)

The Navigation Display (ND) can provide a weather radar image in all modes, except PLAN.

Note : *In case avionics ventilation is not sufficient (e.g. due to a blower and extract fan failure), and the Navigation Display (ND) Unit temperature exceeds a defined threshold, the ND will not display the weather radar image, in order to limit power consumption and prevent a DU overheat. Any additional increase in temperature will lead to a complete cut off of the power supply to this display unit.*

R
R

ROSE MODES

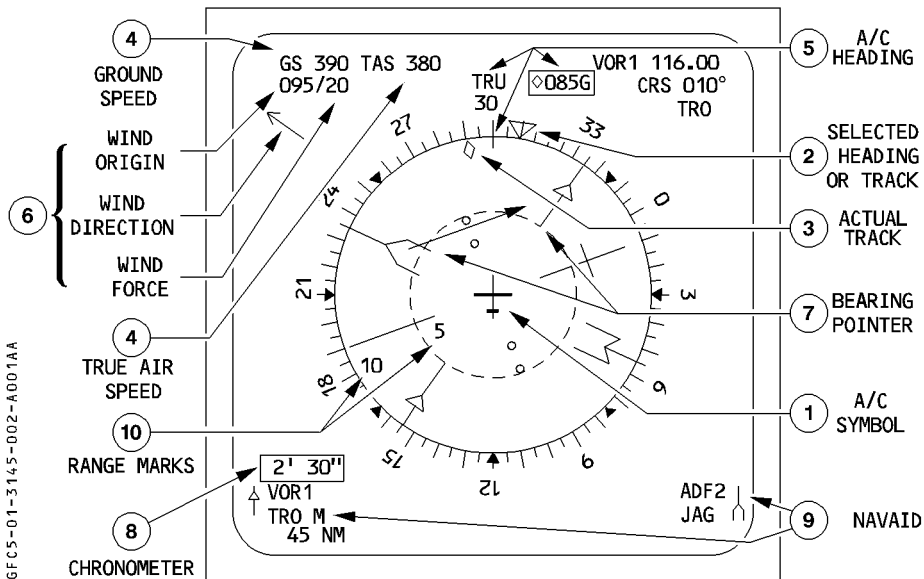

① Aircraft symbol (yellow)

Fixed and centered in the display, this symbol points to the yellow lubber line.

② Selected heading or track (blue)

This pointer shows the heading or track indicated on the HDG TRK counter of the FCU.

③ Actual aircraft track (green)

This symbol is a small green diamond.

④ Ground speed and true air speed (green)

ADIRS furnishes these speeds.

 AIRBUS TRAINING A330 SIMULATOR FLIGHT CREW OPERATING MANUAL	INDICATING/RECORDING SYSTEMS	1.31.45	P 3
	INDICATIONS ON ND	SEQ 001	REV 10

⑤ Aircraft heading

The fixed yellow lubber line points to the aircraft magnetic heading on the moving white compass rose. Small white triangles are fixed at 45° intervals on the circumference of the compass rose.

At latitudes above 82° North or 60° South (or when entering the north magnetic polar region, latitude 73° N and longitude between 120° W and 90° W), the ADIRUs replace magnetic heading with true heading on the EFIS and DDRMI.

When the aircraft is close to these regions (-0.5° away), the ADIRU causes "SELECT TRUE REF" to appear on the ND. When the crew selects TRU, "TRU" appears in blue above the heading scale.

TRU (blue) :

This appears on the ND when the compass is in the true heading configuration. The message flashes for 9 seconds, or until the slats are extended, then it is steady.

Grid track (green) :

The ND displays the grid track in numerical form, when switch is in true reference and the latitude is above 65° N or S.

⑥ Wind direction and speed

ADIRS furnishes the wind direction and speed. The digital direction is with respect to true north, and the analog direction (green arrow) is with respect to magnetic north. The arrow appears only if the wind speed is greater than two knots and the true airspeed is above 100 knots.

If the display does not receive either wind speed or direction, dashes replace the numbers on the display.

⑦ Bearing pointer

The ND displays the bearing pointer when bearing data is available. The pointer is :

- Green for ADF
- White for VOR

If ROSE NAV or ARC mode is selected, and the computer detects a mismatch between the aircraft and VOR reference, the bearing pointer appears in magenta. The VOR bearings are true bearings, having been corrected with the magnetic variation of the

R actual aircraft position (See also FMGS PILOTS GUIDE – POLAR NAVIGATION, 4.04.40). If reception of a beacon ceases, or if the receiver fails, the associated bearing pointer disappears.

8 Chronometer indication (white)

These numbers appear when the onside chronometer is started.

They display the elapsed time.

The indication is in minutes and seconds from 0 to 59' 59", and in hours and minutes from 1 H to 99 H 59'. (Seconds are not displayed beyond 59' 59").

9 Nav aids

When the ADF-OFF-VOR selector switch on either the pilot's or co-pilot's EFIS control panel is set to ADF or VOR, the onside ND displays the following characteristics of the corresponding navaid in white for VOR or in green for ADF (left side for receiver 1 and right side for receiver 2) :

- Type of navaid (ADF or VOR) ;
- Shape and color of the associated bearing pointer (if the bearing pointer is in view);
- Navaid identification (or frequency by default) ;
- DME distance, if a DME is collocated with the selected VOR ADF, and the DME distance are never displayed at the same time.
- Mode of tuning :
 - M for a navaid manually tuned by the pilot through the MCDU (underlined and dimmed),
 - R for a navaid tuned from an RMP (Radio Management Panel) (underlined and dimmed),
 - Nothing for a navaid automatically tuned by the FMGC.

If reception fails, the ND stops displaying the associated data (except for the identification or frequency).

- If there is a mismatch between the aircraft and VOR reference, the following messages are displayed next to the navaid parameters :
 - In case ROSE NAV or ARC mode is selected : CORR (magenta).
 - In case ROSE VOR or ROSE LS mode is selected : MAG or TRU (amber) according to VOR reference.

Also see FMGS PILOTS GUIDE – POLAR NAVIGATION (Refer to 4.04.40).

10 Range marks

The range scale value, selected on the EFIS control panel (10 to 320 NM), governs the scale of the ND.

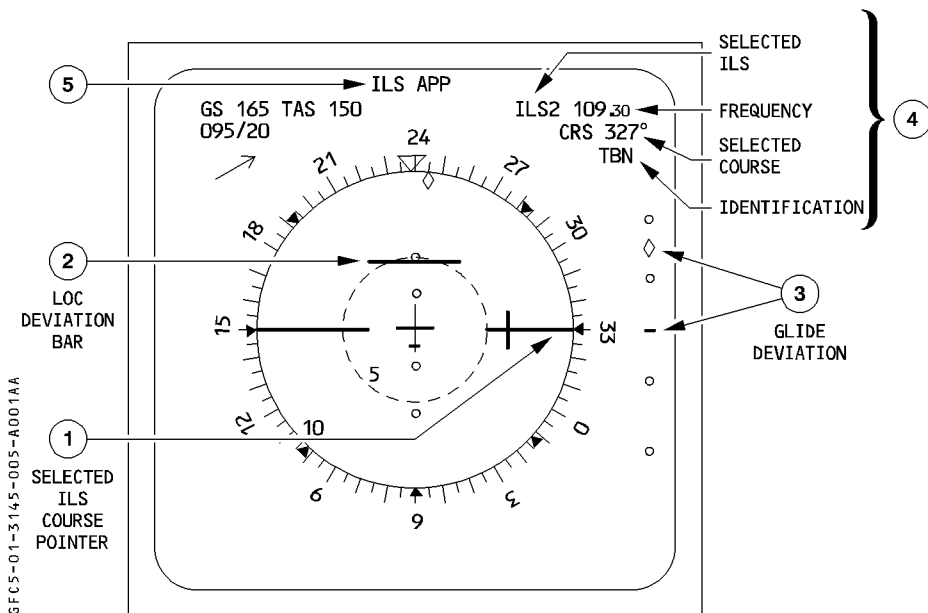
R ROSE LS MODE

① ILS course pointer (magenta)

This dagger-shaped symbol points to the selected ILS course.

The ILS is selected either by the FMGC (autotuned or manually) or through the RMP in backup mode.

② Localizer deviation bar (magenta)

This bar moves laterally with respect to the course pointer. Its scale consists of two dots on each side of zero deviation. Each dot represents a deviation of about $\pm 0.8^\circ$.

If the deviation becomes excessive (1/4 dot, 0.2°) above 15 feet RA, the bar and the scale pulse.



③ Glide deviation (magenta)

This diamond moves on a vertical scale consisting of two white dots on each side of the yellow reference line. Each dot represents a deviation of about $\pm 0.4^\circ$.

If the deviation becomes greater than one dot above 100 feet RA, the scale and the diamond flash.

④ Selected ILS information

This display shows the ILS frequency (magenta), selected course (blue), and identification (magenta).

⑤ ILS APP message (green)

These letters appear when an ILS approach has been selected on the MCDU.

Note : *ILS1 information appears on PFD1 and ND2.*

ILS2 information appears on PFD2 and ND1.



ROSE VOR MODE

R

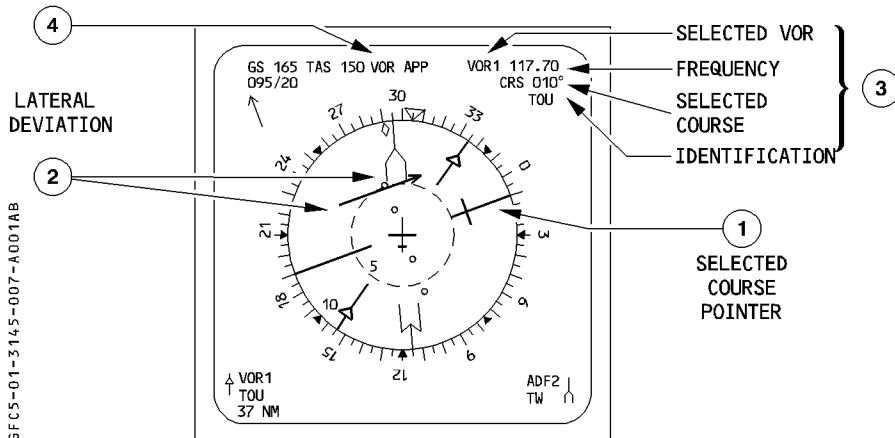

① VOR course pointer (blue)

This dagger-shaped symbol points to the selected VOR course.

The VOR course is automatically selected by the FMGC or manually by the crew using the MCDU pages or the RMP backup mode.

② Lateral deviation bar (blue)

This bar shows the VOR deviation on a lateral scale.

Each dot represents 5°. When the lateral deviation exceeds 10°, the bar remains displayed on the outer dot.

The arrow on the bar gives the TO/FROM indication.

③ VOR information (white)

This area displays the frequency of the selected VOR and its identification (decoded by the receiver), the selected course, and the tuning mode.

④ VOR APP message (green)

These letters appear when a VOR approach has been selected on the MCDU.

ROSE NAV MODE / ARC MODE

ROSE NAV and ARC modes provide the same information, but ARC mode is limited to the forward 90° sector.

The ROSE NAV and ARC mode displays are oriented with respect to the aircraft track (track-up).

Therefore, since the display is not oriented with the same reference as the outside world, the bearing of a given object (aircraft, runway, radar echo, beacon...) is not the same. This must be kept in mind, when the crew needs to go from instrument flight to visual flight.

Note : The compass rose is oriented to magnetic or true north, depending on the NORTH REF pushbutton selection.

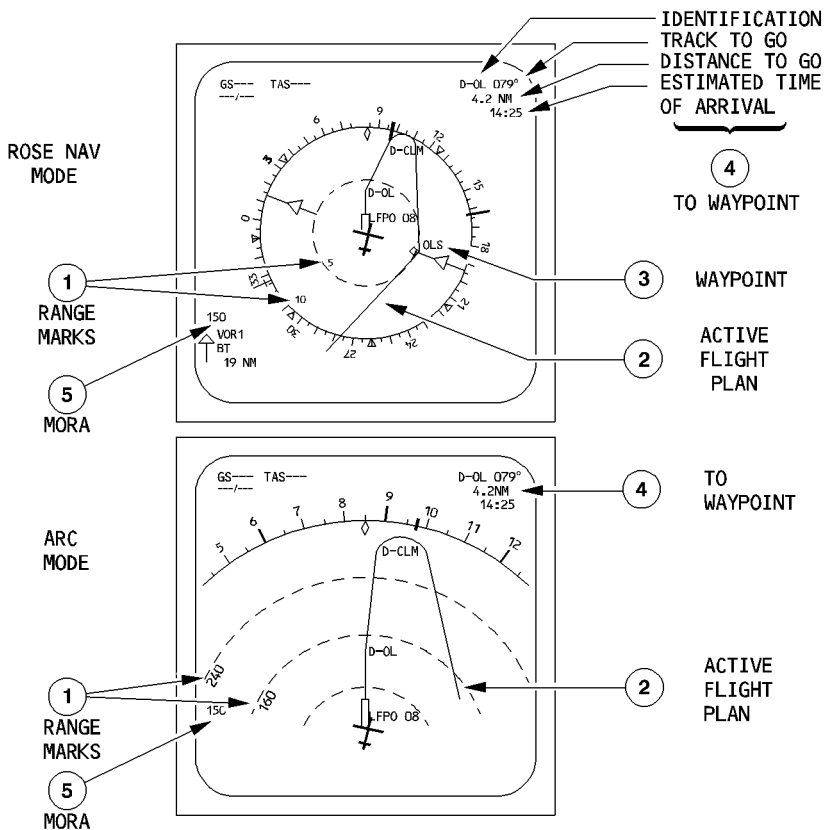

6FC5-01-3145-008-A 200AA

AIRBUS TRAINING  A330 SIMULATOR FLIGHT CREW OPERATING MANUAL	INDICATING/RECORDING SYSTEMS		1.31.45	P 9
	INDICATIONS ON ND		SEQ 001	REV 08

① Range Marks and Values

- R The values displayed on the ND are :
- In ROSE NAV mode
 - 1/4 of the selected range for the inner circle.
 - 1/2 of the selected range for the heading scale circle.
 - In ARC mode
 - 1/4 of the selected range for the first inner arc.
 - 1/2 of the selected range for the second inner arc.
 - 3/4 of the selected range for the third inner arc.

② Flight Plan

The crew can use the MCDU to select various types of flight plan :

- The active flight plan (the flight plan the aircraft is actually following when the NAV mode is engaged) is represented by a continuous green line. The ND shows only the part of the flight plan that is ahead of the aircraft, as well as the waypoints that are still to be overflown and the waypoint from which the aircraft is coming.

The ND does not show a SID or a STAR, except for the last waypoint of the SID and the first waypoint of the STAR, when the selected range is 160 or 320 NM.

If the primary flight plan is not active, it is represented by a dotted green line.

- A continuous blue line portrays the missed approach procedure, and a dashed blue line portrays the flight plan to the alternate.

The missed approach and the alternate flight plan are displayed when :

- In ARC or ROSE NAV mode, a missed approach waypoint or an alternate flight plan waypoint is displayed on the outside MCDU.
- In PLAN mode a missed approach or alternate waypoint is displayed in the 2L field of the outside MCDU.

- The secondary flight plan is represented by a continuous white line. The ND continues to display the active flight plan.

- Temporary flight plan

The revised portion of the flight plan is represented by a dotted yellow line.

- Flight plan capture

When the aircraft is off the primary flight plan and is flying toward it in HDG mode with the NAV mode armed, the ND shows the new active flight plan as a continuous green line if the FMGC has computed the intercept path.

The part of the flight plan before the interception point shows as a dotted green line.

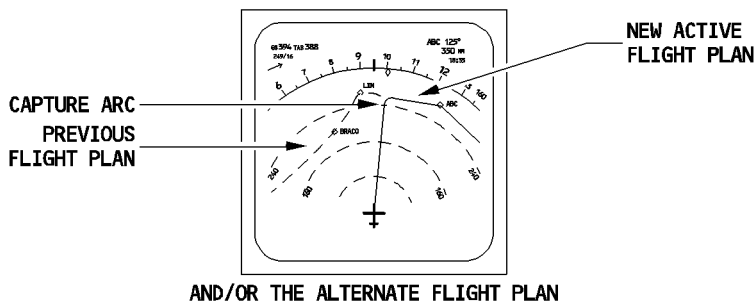

6FC5-01-3145-010-A002AA

R · Abeam/Radial vectors

R The pilot can select on the MCDU to have the display of :

R · either the radial of a selected waypoint perpendicularly to the aircraft present track (Abeam)

R · or the selected radial of a waypoint (Radial)

R These vectors are displayed using a dashed blue line.

③ Waypoint

The ND can display various kinds of waypoints :









Flight plan waypoints

The ND displays these as green diamonds (white, for TO waypoints). When the pilot selects the WPT option on his EFIS control panel, all waypoints other than flight plan waypoints are displayed in magenta.

Pseudo waypoint

Point of the flight path where the aircraft is predicted to reach a selected altitude or speed.

R

Pseudo waypoint	Definition
	Level symbol (top of climb or level-off position), at the point where the aircraft will reach : <ul style="list-style-type: none"> · The FCU-selected altitude (blue arrow). · It is displayed in magenta, if it corresponds to a constraint. · It does not appear when the aircraft is within 100 feet above, or below, the selected altitude.
	Top of descent symbol, or continue descent, symbol : <ul style="list-style-type: none"> · White, if DES is not armed. · Blue, if DES is armed.
	Start of climb symbol : <ul style="list-style-type: none"> · White, if CLB is not armed. · Blue, if CLB is armed.
	Intercept point symbol : <ul style="list-style-type: none"> · Indicates the point at which the aircraft will intercept the FMGC-computed descent profile. · White, if DES is not armed. · Blue, if DES is armed.
	Speed change symbol (magenta) : <ul style="list-style-type: none"> · Indicates the point at which the speed has to change.
	Decelerate point symbol (magenta) : <ul style="list-style-type: none"> · Indicates the point at which the aircraft is predicted to decelerate for approach (and thus switch to the approach phase). · Magenta, if in managed speed and NAV or approach mode is engaged. · White, if in selected speed or HDG/TRK mode. · Automatic decelerations only occur when displayed in magenta.
	<ol style="list-style-type: none"> 1. ALT CSTR symbol set around the constrained waypoint : <ul style="list-style-type: none"> · Magenta, when the ALT CSTR is predicted to be satisfied. · Amber, when the ALT CSTR is predicted to be missed. · White, when the ALT CSTR is not taken into account by the guidance, and the NAV mode is engaged. 2. Time marker or equitime point symbol appears in green, to indicate when the aircraft reaches the time marker or equitime point.
	ENERGY CIRCLE symbol (green arc) : <ul style="list-style-type: none"> · The radius represents the required distance to land from the present position. · It is computed by the FMGC and is only available in ROSE NAV and ARC modes.

3 Waypoint (Cont'd)

GFC5-01-3145-012-A202AA

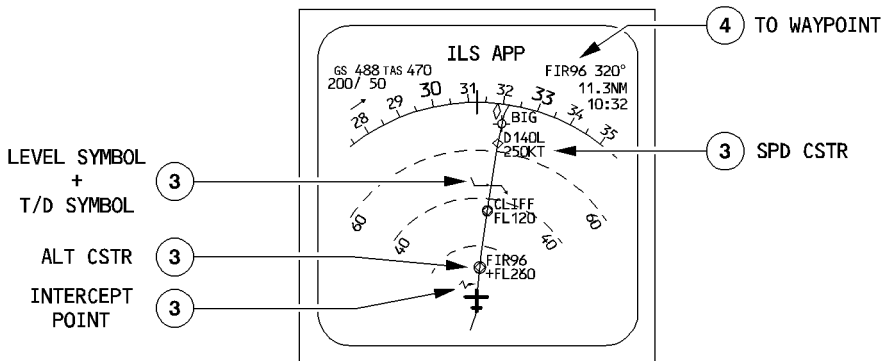

4 TO waypoint

This is the next waypoint to be overflown.

This area of the screen also shows :

- Waypoint identification (white).
- Track to go (green).
- Distance to go (green).
- Estimated time of arrival (green), assuming the aircraft will fly directly from its present position to the TO waypoint at the current ground speed.

5 Minimum Off Route Altitude (MORA)

Provided CSTR is selected and range is selected equal to or above 40 NM a digital readout (Flight Level) is displayed which represents the Minimum Off Route Altitude allowed in a circle of 40 NM around the aircraft. Nothing is displayed, if MORA for the chosen flight route is not available in the FMGS database.

GFC5-01-3145-012-B202AA

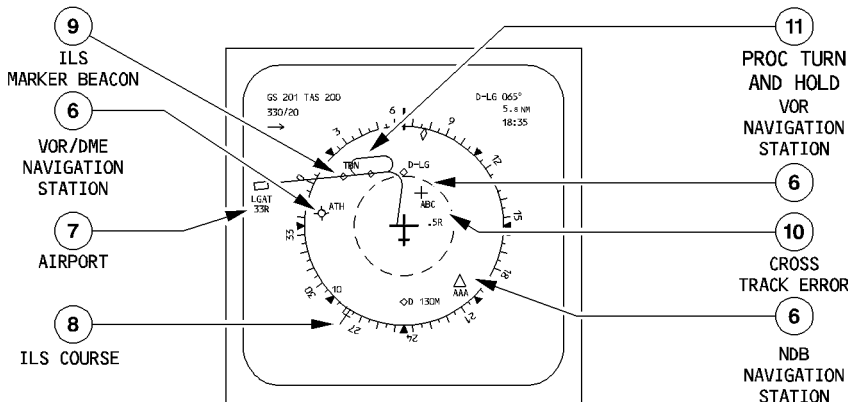



⑥ Nav aids

The display uses specific symbols for nav aids :

○ DME or TACAN

+ VOR

○ VOR/DME

△ NDB

The symbol appears :

- In green if the nav aid is a current waypoint of the flight plan.
- In white if it is the TO waypoint.
- In blue when the nav aid is tuned for display either automatically by the FMGC or manually through the MCDU.
- In magenta when the nav aid is not part of the flight plan and is called for display as an option (corresponding option pushbutton pressed on the FCU EFIS control panel).

⑦ Airport

Airport included in the flight plan :

- If the runway is not specified, the airport is represented by a star and the identification is displayed in white.

Example : * LSGG

- If the runway is specified, it is represented by an oriented runway symbol in white.

8F65-01-3145-015-R002A



LSGG
33R

The runway is drawn to scale (paved length) if the selected range is 10, 20 or 40 NM.

Optional airport information

The airports that are not displayed as part of the flight plan may be called for display (ARPT pushbutton on the EFIS control panel).

They are represented by a star and the identification in magenta.

⑧ ILS Course (Magenta)

- R When the pilot pushes the LS pushbutton switch on the EFIS control panel, and if an ILS station has been selected, the display shows an ILS course symbol.

⑨ ILS Marker Beacons

The screen shows these as waypoints (diamonds).

When the aircraft overflies a marker beacon, the corresponding symbol flashes :

Blue for the outer marker.

Amber for the middle marker.

White for the inner marker.

⑩ Cross track error

This is the aircraft's lateral deviation from the active leg of the flight plan (related to the great circle route). It is indicated in nautical miles (NM), with the letter R (right) or L (left), according to the position of the aircraft with respect to the flight plan.

⑪ Procedure turns and holding patterns

These appear only when they are part of the flight plan. For the 160 and 320 NM range scales, each one is represented by a white arrow that originates at the associated fix and indicates the direction of the turn.

GFC5-01-3145-014-A002AA

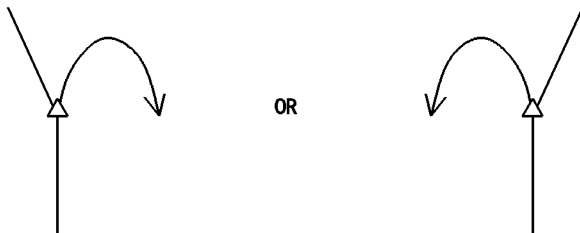

For shorter range scales and if the procedure turn or the holding pattern is in the next or the active leg, the display shows the full circuit or pattern.

GFC5-01-3145-014-B002AA





PLAN MODE

This mode statically displays the flight plan legs on a map oriented to true north. The map is centered on a map reference point that the pilot selects by slewing to it on his MCDU. The map reference point is the waypoint displayed on the second line of the MCDU F-PLN page. It can either be the active waypoint (next waypoint to be overflown), or any other waypoint of the flight plan.

The pilot can slew the overall flight plan and display it in PLAN mode.

The pilot chooses the scale of the map with the range selector. (The diameter of the outer circle corresponds to the selected range).

Data on nav aids, and their characteristics and associated bearing pointers, are not available in this mode.

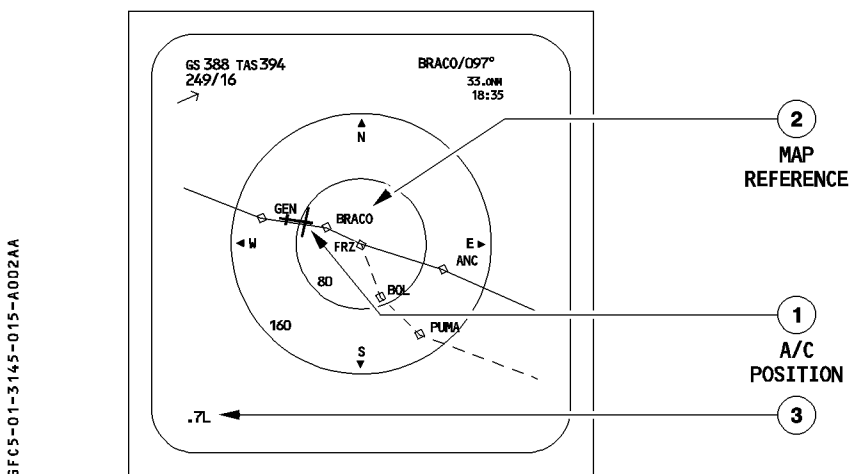

① Aircraft position and true track

The orientation of the yellow aircraft symbol always indicates the aircraft's true track. Its position represents the aircraft position given by the FMGS.

② Map reference point

③ Crosstrack error

R See ROSE NAV MODE/ARC MODE.

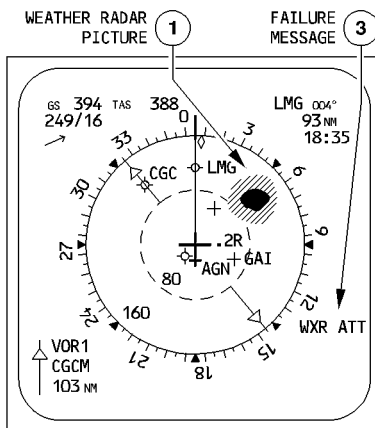
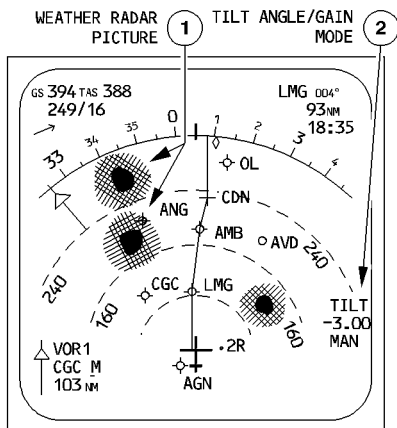
WEATHER RADAR① Weather Radar Picture

- R – When the radar is operating, and when the ND is not in PLAN mode, the ND displays the weather radar picture.
- R – The echoes appear in different colors, depending on the precipitation rates (black, green, yellow, red or magenta).
- R – The selected ND range will determine how often the image is refreshed.

② Tilt Angle and Gain Mode

- R – The value of the tilt angle is in degrees, and quarters of a degree. It appears in blue in the lower right-hand corner of the screen. This angle is the angle between the horizon and the radar beam axis.
- R – “MAN” appears in white, when the manual gain mode is selected.



③ Failure Messages

The ND lists the detected failures.

If the message is in "red", the ND does not display a radar image.

If the message is in "amber", the image is not affected.

WXR RT (red) : Radar transceiver failure.

WXR ANT (red) : Radar antenna failure.

WXR DU (red) : Overheating of the display unit

WXR CTL (red) : Radar control unit failure.

WXR RNG (red) : Range error.

WXR WEAK (amber) : Calibration failure.

WXR ATT (amber) : Attitude control failure.

WXR STAB (amber) : Antenna stabilization failure.



PREDICTIVE WINDSHEAR SYSTEM

R

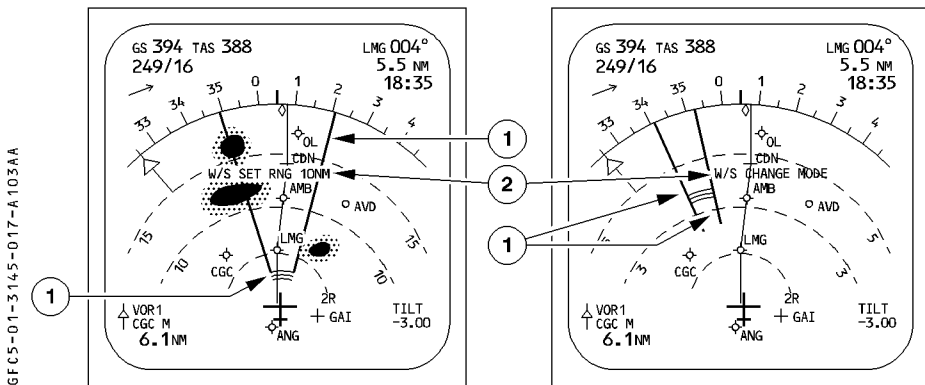

① Predictive windshear area indication

The predicted windshear areas are indicated by a red and black icon and two yellow radial lines. Windshear information is available in ARC and ROSE ND modes, and is displayed even if the weather radar is switched off, provided the WINDSHEAR switch on the weather radar panel is set to AUTO.

Depending on the windshear alert level, the ND indication may be complemented by a PFD message (Refer to 1.31.40).

R ② Windshear messages (W/S : CHANGE MODE, W/S : SET RNG 10 NM)

R These messages are displayed (in amber for caution alert, red for warning alert) on the
 R ND, when a windshear event is detected and the mode (W/S:CHANGE MODE) or range
 R (W/S:SET RNG 10 NM) of the ND is inadequate to display the windshear echoes.

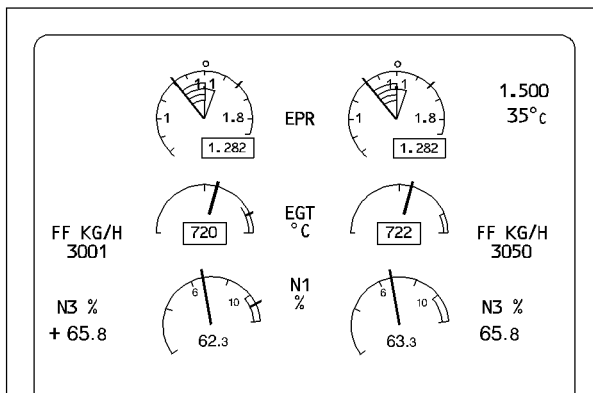
ENGINE STANDBY PAGE

In case all ECAM DMC channels fail, each pilot may display the engine standby page on their ND by means of the ND selector on the EFIS control panel.

The displayed information is N1, N3, EPR, EGT, FF, and limit modes (same presentation as the upper part of the primary engine page).

This information is generated by the EFIS channel of the DMCs.

For more information on this page, see the POWERPLANT Chapter (Refer to 1.70.95).

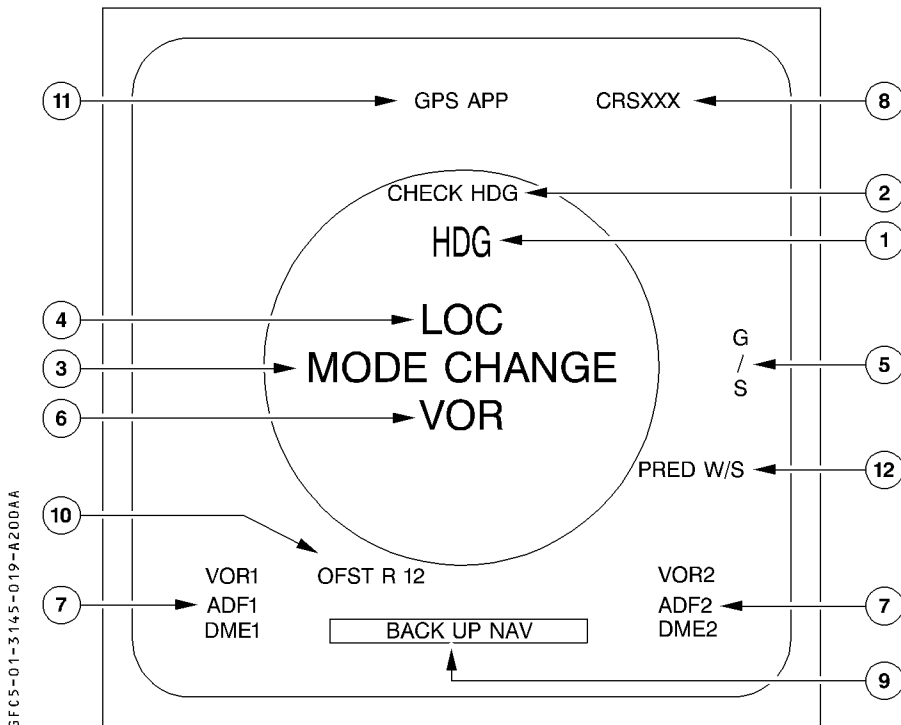
FLAGS AND MESSAGES DISPLAYED ON ND**① HDG flag (red)**

In case the heading data fails, the rose, arc and associated symbols disappear. A HDG flag flashes for 9 seconds, then remains steady in the upper part of the ND.

② CHECK HDG flag (amber)

When a disagree (5°) is detected by the FWC between sides 1 and 2, a CHECK HDG flag appears on both NDs, associated with an ECAM caution. This message is not available, when plan mode is selected.

③ Center Part Messages

- The screen displays a **MODE CHANGE** message in green if there is a discrepancy between the selected mode on the EFIS control panel and the mode sent from the outside FMGC, or while the DMC is preparing a new page for display.
- The screen displays a **RANGE CHANGE** message in green if there is a discrepancy between the range selected on the EFIS control panel and the range sent from the outside FMGC. A **MODE CHANGE** message has priority over a **RANGE CHANGE** message.
- The screen displays a **MAP NOT AVAIL** message in red for several reasons :
 - The **MODE CHANGE** or **RANGE CHANGE** message has been displayed more than six seconds.
 - A disagreement between DMC and FMGC has been detected while EFIS control panel is failed (default mode ROSE NAV 80 NM).
 - The FMGC is not able to indicate the flight plan reference point (back up mode) while **PLAN** mode is selected.
 - The FMGC has failed.
 - The FMGC has delivered an invalid aircraft position.
- The screen displays **CHECK ND (1,2)** message (amber) when the DMC detects a discrepancy between acquisition and display of parameters.
- The screen displays **CHECK EWD** message (amber) when the DMC detects a discrepancy between acquisition and display of E/WD parameters.
- The screen displays a **W/S SET RNG 10 NM** message if a predictive windshear alert is triggered and the range is above 10 NM.
- The screen displays a **W/S CHANGE MODE** message if a predictive windshear alert is triggered and the ND is not in **ARC** or **ROSE** mode. The message appears in the red or amber corresponding to the windshear alert.

④ LOC Flag (red)

If LOC data fails, this flag flashes for nine seconds, then remains steady.

⑤ G/S Flag (red)

If G/S data fails, this flag flashes for nine seconds, then remains steady.

⑥ VOR Flag (red)

In **ROSE VOR** mode, when the VOR bearing is not valid, this flag flashes for nine seconds, then remains steady.

⑦ VOR1(2) or ADF1(2) or DME1 Flag (red)

If a navigation receiver fails, the appropriate one of these flags flashes for nine seconds, then remains steady.



8 VOR Course Flag

If the VOR course fails, a red CRSXXX flag appears.

If there is Non-Computed Data (NCD), a blue CRS - - - flag appears.

9 Other messages

- MAP PARTLY DISPLAYED (amber) : In case of incomplete data transmission between the FMGC (priority criteria) and the DMC, or if the DMC cannot draw the complete MAP.
- NAV ACCUR UPGRAD or (white)
NAV ACCUR DOWNGRAD (amber) : Signals a change in navigation accuracy.
- SPECIF VOR/D UNAVAIL (amber) : If the navaid, that is tuned for the selected approach or departure, is not available.
- BACK UP NAV (amber) : If the MCDU backup navigation mode is activated (refer to 1.22).
- OFF SIDE FM CONTROL (amber) : If the offside FM supplies the ND.
- CHK FLT PLN POSITION (amber) : On ARC or ROSE NAV mode, if the DMC detects a disagree between the acquisition and the display of the flight plan.
- SELECT TRUE REF (amber) : When entering the polar area, if the TRUE North reference is not selected by the flight crew (MAG/TRUE pushbutton).
- CHECK NORTH REF (amber) : The NORTH REF pushbutton selection does not match the airport MAG/TRUE bearing reference (as stored in the FMGS navigation database), either at the departure airport (during preflight), or at the destination airport (when entering the ARRIVAL area).
- ↓ (green) : Overflow arrow, displayed when more than one of the following messages are present at the same time :
 – NAV ACCUR DOWNGRAD
 – NAV ACCUR UPGRAD
 – SPECIF VOR/D UNAVAIL
 – SELECT TRUE REF
 – CHECK NORTH REF
 – GPS PRIMARY
 – GPS PRIMARY LOST
- GPS PRIMARY (white, boxed white) : This message appears when GPS PRIMARY mode is available, or has been recovered. The pilot can clear this message by pressing the CLR key on the MCDU.
- GPS PRIMARY LOST (amber, boxed white) : This message appears when GPS PRIMARY is not available, and is not clearable by pilot action.

**⑩** OFST R(L) XX message (yellow)

This message is displayed, when a temporary or an offset flight plan is entered. The offset value is given in NM.

Note : For TCAS messages (Refer to 1.34.80).

⑪ GPS APP (green)

This message is displayed, when a GPS approach has been selected.

⑫ PRED W/S flag (amber)

The WINDSHEAR switch on the weather radar panel is set to AUTO, and a Predictive Windshear System Fault is detected. This message appears on ground, or when flaps and slats are extended.

It is associated with a single chime. The radar image remains available, provided that the fault does not affect the radar mode.

EGPWS

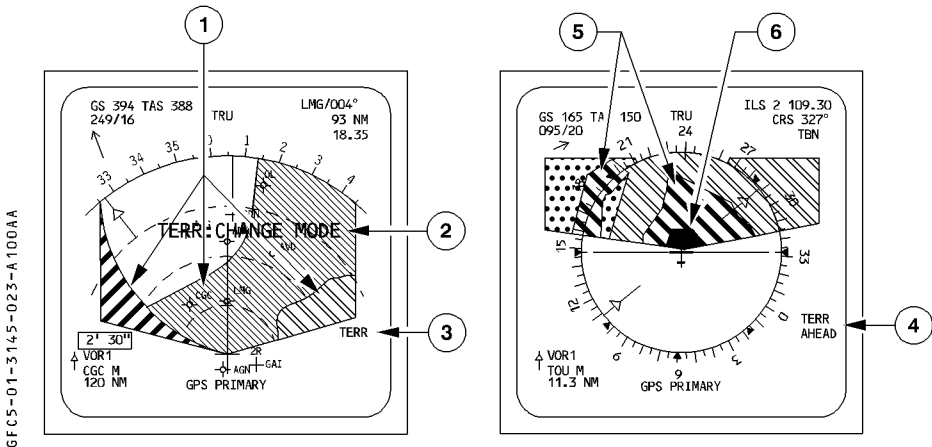

① EGPWS terrain picture

The ND presents the EGPWS terrain picture, when the TERR ON ND switch is selected ON, and the ND is not in PLAN or ENG mode. The terrain picture replaces the weather radar image.

The terrain appears in different colors and densities, according to its relative height :

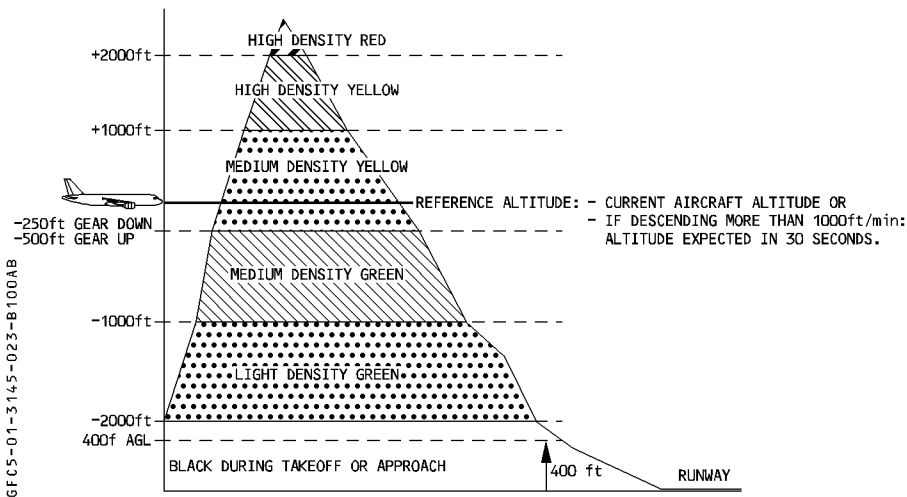

R Note : Areas without available terrain data in the EGPWS database appear in magenta.

② TERR : CHANGE MODE indication

Displayed in red (or amber), in case of a Terrain Awareness Display (TAD) warning (or caution) alert, if the current selected display mode is PLAN.

③ TERR indication

To differentiate between the terrain and the weather display, the weather radar TILT is replaced by a blue TERR, and the terrain display sweeps from the center outward to both NDs' sides.

④ Warning and caution messages

TERR AHEAD (amber) : For a caution.

TERR AHEAD (red) : For a warning.

When triggered, these messages flash for 9 seconds, then remain steady until the caution or warning alert condition disappears.

TERR RNG (red) : For a RANGE error warning.

TERR TST (amber) : Appears during the EGPWS test, when the terrain pattern is displayed, and there is no failure.

⑤ Terrain caution alert

Generated when a conflict exists between the terrain caution envelope, ahead the aircraft, and the terrain data stored in the database. The conflict area is shown in solid yellow.

⑥ Terrain warning alert

Generated when a conflict exists between the terrain warning envelope, ahead the aircraft, and terrain data stored in the database. The conflict area is shown in solid red.

Note : When an alert is generated (either caution or warning), and TERR ON ND is not selected, the terrain is automatically displayed and the TERR ON ND pushbutton ON light comes on.

R



EFIS CONTROL PANEL

R

6FCS-01-3150-001-A100AA

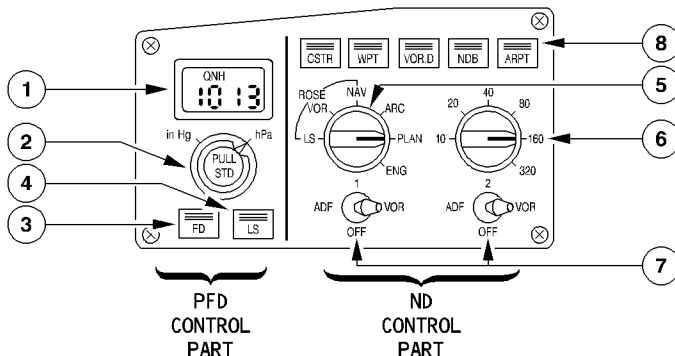

① Barometer Reference Display Window

Range : 745 hPa to 1100 hPa.

② Barometer Reference Selector

- a) Outer ring : For selection of the units for the barometer reference, either hectoPascals or inches of mercury.

Note : The selected unit does not appear on the PFD.

- b) Inner knob : For selection of the reference value, displayed in the barometer reference display window and on the PFD below the altitude scale.

At FCU initialization, the window displays 1013 or 29.92, depending on the selected unit.

- Pulling the knob selects the standard baro reference setting. The PFD then displays "STD." (Rotating the knob has no effect.)
- Pushing the knob from the STD position makes the last selected QFE or QNH baro setting available.
- Pushing the knob again, changes QNH to QFE or vice versa. The window displays "QNH" or "QFE", depending on the pilot's selection.

Note : The QFE option is a pin-program, installed on the FMGC and GPWS computers. These computers will work using the selected pin-program (QNH or QFE), independently of the baro reference setting selected on the EFIS CTL panel.



③ FD Pushbutton

Pushing this button removes the FD bars from the associated PFD (or removes the flight path director symbol if the TRK FPA reference is selected).

The pushbutton light goes out.

Pushing it again restores the FD bars (or the FPD symbol) and lights the green pushbutton light.

④ LS Pushbutton

Pushing this button displays the localizer and glide slope scales on the PFD.

Deviation symbols appear if there is a valid ILS signal.

The green pushbutton light comes on.

⑤ Mode Select Switch

This switch selects a navigation display for the outside ND.

⑥ Range Select Switch

This switch selects a range scale for the outside ND.

Note : If the mode or the range data fails, the default selection is the ROSE NAV mode and 80 NM range.

⑦ ADF-VOR Select Switches

These switches select ADF or VOR bearing pointers and DME distance on the outside ND, as well as the corresponding navaid data characteristics in any mode except PLAN mode.

⑧ Optional Data Display Pushbutton

Pushing this button displays optional data in addition to the data permanently displayed in PLAN, ARC, or ROSE NAV modes. The green pushbutton light comes on.

Only one option can be activated at a time.

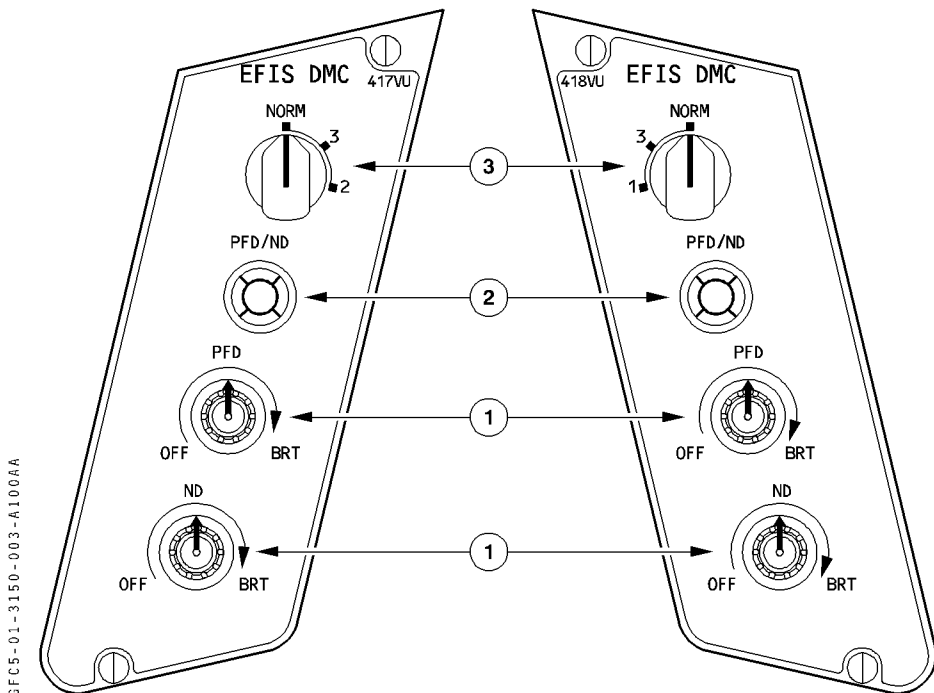
EFIS DMC PANEL**① OFF/BRT knobs**

- These knobs turn the PFD and ND display units on and off, and control their brightness.
- The display brightness automatically adjusts for changing light conditions. It may also be adjusted manually.

PFD Brightness Control Knob

Rotating this knob all the way counterclockwise switches off the PFD. In this case, the PFD image is automatically displayed on the NDU, but the pilot may recover the ND by means of the PFD-ND XFR pushbutton.

ND Brightness Control Knob

The outer knob controls the brightness of both the weather radar image and the EGPWS terrain display.

The inner knob controls the general brightness of the ND symbols.

Rotating this knob all the way counterclockwise switches off the NDU.

② PFD/ND Pushbutton

Pushing this button interchanges the PFD and the ND.

If the PFDU fails, the PFD automatically transfers to the NDU.

③ EFIS DMC sel

NORM : The DMC 1 supplies CAPT EFIS DUs and DMC 2 supplies F/O EFIS DUs.

3 : The onside DMC is replaced by DMC3.

2 or 1 : The onside DMC is replaced by DMC 2 or 1.

R Some switching configurations generate FMA message. Refer to 1.22.30 for details.

CHRONOMETER (glareshield)

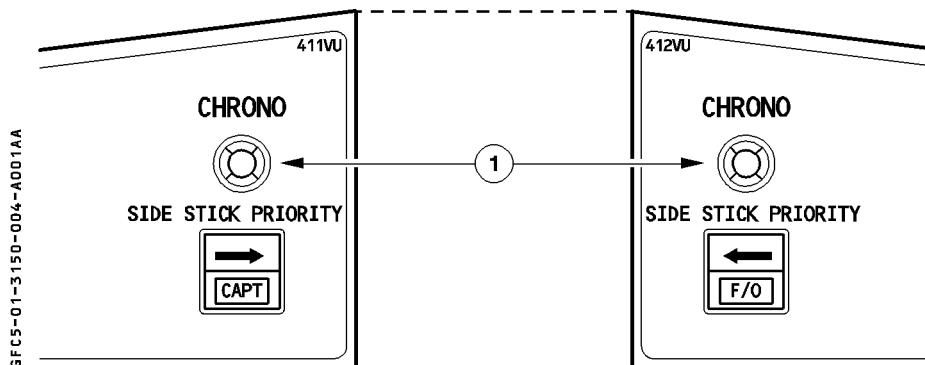

① CHRONO Pushbutton

Pushing this button displays chronometer time on the onside ND.

Pushing it again freezes the displayed value.

Pushing it a third time resets the chronometer, and the chronometer time disappears from the display.

 AIRBUS TRAINING A330 SIMULATOR FLIGHT CREW OPERATING MANUAL	INDICATING/RECORDING SYSTEMS	1.31.55	P 1
	CLOCK	SEQ 100	REV 12

GENERAL

- R A fully independent clock is on the right side of the control panel. It sends time to the central maintenance computer, the Flight Data Interface Unit, and the Flight Management and Guidance Computer. The clock has two electrical supplies, one of which is a direct connection to the aircraft battery hot bus. The clock performs four functions :
- It displays “UTC” (GMT) time in hours, minutes, and seconds, on the center counter.
 - It displays elapsed time (ET) (from engine startup) in hours, and minutes, on the lower counter.
 - It drives the chronometer (CHR), which measures a time interval (from the pushing of the CHRONO button) in minutes and seconds, and displays it with a needle and in numbers on the upper counter.
 - It can replace the UTC with the date.

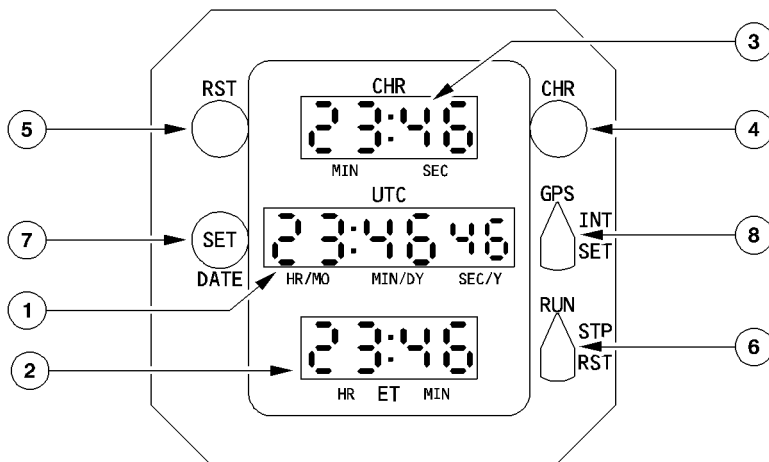
CONTROLS AND INDICATORS

GFC5-01-3155-002-A120AA

① UTC (GMT) counter

This counter displays the present time in 24-hour format from 0 to 23 hours 59 minutes 59 seconds.

② Elapsed Time (ET) counter

This counter registers the aircraft's flight time from 0 to 99 hours 59 minutes.

③ Chrono (CHR) counter

This counter registers elapsed time from 0 to 99 minutes 59 seconds. It is controlled by the CHR pushbutton.

 AIRBUS TRAINING A330 SIMULATOR FLIGHT CREW OPERATING MANUAL	INDICATING/RECORDING SYSTEMS	1.31.55	P 3
	CLOCK	SEQ 120	REV 13

④ CHR pushbutton

First push : Starts the CHR counter.

Second push : Stops the CHR counter, and keeps the display at its last indication.

⑤ Reset (RST) pushbutton

When pressed, the CHR counter restarts from 0, if the chrono is running.

⑥ ET selector

“RUN” : The ET counter starts

“STP” : The ET counter stops counting

Spring-loaded “RST”: The ET counter goes blank. The selector returns to its STP position when the selector is released.

Note : A cumulative elapsed time can be achieved by alternatively setting this switch to the “RUN” and “STP” position.

⑦ DATE/SET button

First push : Sets the clock to date mode. The UTC time display is replaced by the date (day/month/year).

Second push : Sets the clock to time mode. The date display disappears.

Note : In order to select the date mode, switch the UTC selector to “GPS” or “INT”.

8 UTC selector

GPS : The time (or date, if selected) is displayed, and this data is synchronized with GPS information.

Note : – If the signal between the GPS and the clock is not detected, or if the signal is detected, but the GPS data is invalid, the clock automatically runs on its internal time.

– The clock will automatically resynchronize with the GPS information, as soon as the GPS data is available.

INT : The internal time (or date, if selected) is displayed.

Note : – The clock's internal time is always synchronized with the latest valid GPS information unless the pilot enters a different internal time via the SET function.

– If there is no valid GPS information at power up, the internal time will be 00:00:00, until the clock is initialized, or until valid GPS information is available.

SET : Allows the internal time and date to be initialized.

INTERNAL TIME AND DATE INITIALIZATION

Set the UTC selector to SET. The minute digits flash, and the seconds' digits are blank. To increase data, turn the DATE/SET pushbutton clockwise.

To decrease data, turn the DATE/SET pushbutton counterclockwise.

- First, press on DATE/SET : To set the hour.
- Second, press on DATE/SET : To set the year.
- Third, press on DATE/SET : To set the month.
- Fourth, press on DATE/SET : To set the day.

Switch the UTC selector to INT, and the clock will start with the seconds' digits at 00.

Note : This process must be completed in less than one minute. Otherwise, it will be necessary to reset the CMC, in order to synchronize the lower ECAM time display with the cockpit clock display. Resetting the CMC is a maintenance operation.

FLIGHT DATA RECORDING SYSTEM**DESCRIPTION**

The Flight Data Recording System, which records the mandatory parameters, consists of the following components :

- A Flight Data Interface Unit (FDIU)
- A Digital Flight Data Recorder (DFDR)
- A three-axis Linear Accelerometer (LA)

The FDIU collects and processes parameters from the SDACs, DMCs, FWCs, FCDCs, BSCU, EIVMUs, FCU, the DFDR event pushbutton, the GND CTL pushbutton and the Clock. It stores the mandatory flight parameters in the DFDR.

The DFDR can store the last 25 hours data, at least. It stores this data on a fireproof and shockproof device. An underwater locator beacon is attached to the DFDR.

The linear accelerometer measures the acceleration of the aircraft along each of the three axes.

R
R

6FC5-01-3160-001-A001AA

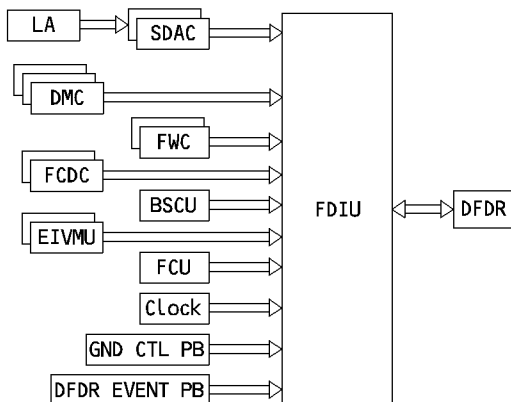

The recording system is automatically active :

- On ground, during the first five minutes after the aircraft electric network is energized.
- On ground, after the first engine start.
- In flight (whether the engines are running or not).

On ground, the recording system automatically stops five minutes after the second engine shuts down.

On ground, the crew can manually start the recording system by pressing the GND CTL pushbutton.

CONTROLS AND INDICATORS**OVERHEAD PANEL**

GFC5-01-3160-002-A001AA

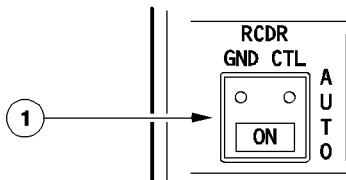
**① RCDR GND CTL pushbutton (springloaded)**

- R – ON : The Cockpit Voice Recorder (CVR) and the Flight Data Recorders are active. The ON light is on.
- R – AUTO : The Cockpit Voice Recorder (CVR) and the Flight Data Recorders are active, according to the logic.

The system automatically switches from ON to AUTO at the first engine start, and also in case of an electrical transient.

PEDESTAL

GFC5-01-3160-002-B001AA

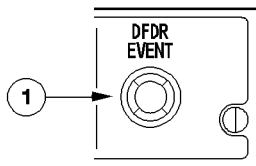
**① DFDR EVENT pushbutton**

- R – Pressing this button (briefly) sets an event mark on the Flight Data records.

AIRCRAFT CONDITION MONITORING SYSTEM (ACMS)

DESCRIPTION

- R The ACMS is used to monitor various aircraft system parameters in order to make
 R maintenance easier and to allow formulating operational recommendations.
 R The ACMS can generate system reports. The Airbus Standard Reports are preprogrammed
 R reports available at aircraft delivery. The operator can create its own reports.
 R The ACMS consists of a Data Management Unit (DMU) connected as shown below.
 R The system may be programmed using the MCDUs. The crew can select any report to be
 R displayed on the MCDUs.
 R The Printer prints the flight phase programmed reports or any report selected on the MCDU.
 R This printing may be automatic or in response to the ACMS PRINT pushbutton.
 R The ACMS may send automatic reports via ACARS (◀)
 R An optional Digital Recorder may be installed to extend the recording capacity.
 R

GFC5-01-3160-003-A100AA

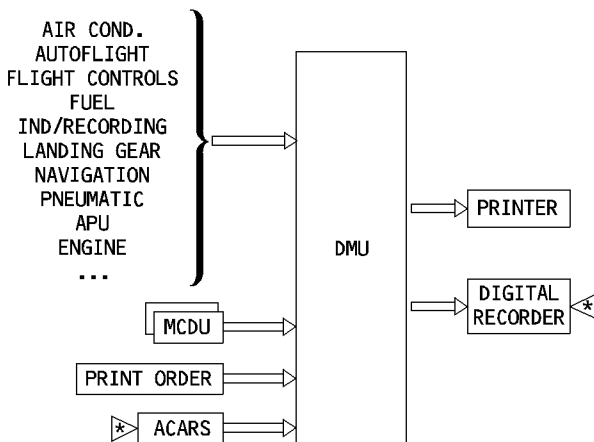

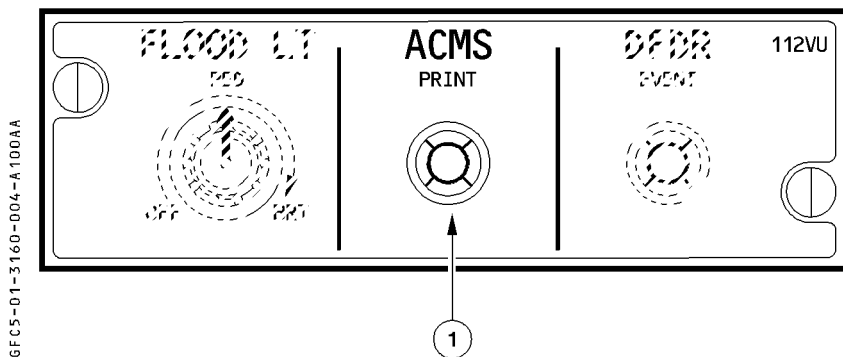
CONTROLS ON PEDESTAL**① ACMS PRINT pushbutton**

This pushbutton is used to immediately print specific report, depending on the flight phase. The crew may then use the MCDU to select and instantly print another report.



WARNINGS AND CAUTIONS

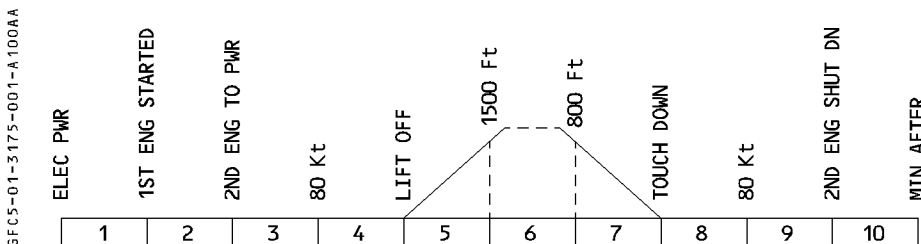

E / WD: FAILURE TITLE conditions	AURAL WARNING	MASTER LIGHT	SD PAGE CALLED	LOCAL WARNINGS	FLT PHASE INHIB				
EFIS DMC 1(2)(3) FAULT failure of the EFIS part of one DMC	SINGLE CHIME	MASTER CAUT	NIL	NIL	4, 5, 7, 8				
ECAM DMC 1(2)(3) FAULT failure of the ECAM part of one DMC				Message on related DU	3, 4, 5, 7, 8				
DISPLAY DISCREPANCY (EWD, SD, PFD or ND)	NIL	NIL		NIL	NIL	4, 5, 7, 8			
FWC 1(2) FAULT					NIL	NIL	NIL	3, 4, 5, 7, 8	
SDAC 1(2) FAULT							SINGLE CHIME	MASTER CAUT	NIL
FWC 1+2 FAULT	NIL	NIL		NIL	NIL	3, 4, 5, 7, 8			
SDAC 1+2 FAULT						SINGLE CHIME	MASTER CAUT	NIL	4, 5, 7, 8
DFDR FAULT						NIL	NIL	NIL	NIL
FDIU FAULT	NIL	NIL		NIL	NIL				
ECP FAULT						NIL	NIL	NIL	NIL
OEB/FWC DISCREPANCY FWC1 and FWC2 do not have the same OEBs listed in their OEB reminder database.	SINGLE CHIME	MASTER CAUT	NIL	NIL	3 to 8				

MEMO DISPLAY

- ECAM SWTG message is displayed in green when the ECAM SWTG DMC selector is not in AUTO position.
- EFIS SWTG message is displayed in green when either the CAPT or the F/O EFIS DMC selector are not in NORM position.



BUS EQUIPMENT LIST

R

		NORM			EMER ELEC		
		AC	DC	DC BAT	AC ESS	DC ESS	HOT
DU	CAPT PFD				X		
	CAPT ND				SHED		
	F/O PFD	AC2					
	F/O ND	AC2					
	E/WD				X		
	SD	AC1					
DMC	DMC 1 EFIS PART				X		
	DMC 1 ECAM PART	AC1			X		
	DMC 2 EFIS PART	AC2					
	DMC 2 ECAM PART	AC2					
	DMC 3 EFIS PART	AC1			X (1)		
	DMC 3 ECAM PART				X (1)		
FWC	FWC 1				X		
	FWC 2	AC2					
SDAC	SDAC 1				X		
	SDAC 2	AC2					
ECP	ECP					X	
CLOCK						X	X
WBS ◀	WBC 1	AC2					
	WBC 1	AC2					
FLT RECORDERS	DFDR	AC2					
	FDIU	AC2					
	QAR ◀	AC1					
	LA		DC1				

(1) In case of switching only.