

 A320 <small>SIMULATOR</small> FLIGHT CREW OPERATING MANUAL	LIGHTS	1.33.00	P 1
	CONTENTS	SEQ 001	REV 32

33.00 CONTENTS

33.10 COCKPIT LIGHTING

- GENERAL 1
- DESCRIPTION 2
- CONTROLS AND INDICATORS 4

33.20 EXTERIOR LIGHTING

- GENERAL 1
- CONTROLS AND INDICATORS 2

33.30 EMERGENCY LIGHTING

- DESCRIPTION 1
- CONTROLS AND INDICATORS 4

33.40 SIGNS

- CONTROLS AND INDICATORS 1

33.50 ELECTRICAL SUPPLY

- R - BUS EQUIPMENT LIST 1

AIRBUS TRAINING  A320 SIMULATOR FLIGHT CREW OPERATING MANUAL	LIGHTS COCKPIT LIGHTING	1.33.10	P 1
		SEQ 001	REV 23

GENERAL

The instrument panel has both integral instrument lighting and flood lighting. The brightness of all panel lighting is adjustable. Incandescent spot lights and flood lights illuminate all work surfaces and the side consoles. Two dimmable dome lights illuminate the overall cockpit. When the batteries are supplying all electrical power, only the righthand dome light is on line.

 AIRBUS TRAINING A320 SIMULATOR FLIGHT CREW OPERATING MANUAL	LIGHTS	1.33.10	P 2
	COCKPIT LIGHTING	SEQ 100	REV 34

DESCRIPTION

Integrated lighting for instruments and panels

All instruments and panels in the cockpit (other than display units) have integral lighting. The brightness of all integral lighting is adjustable.

Annunciator lights

The ANN LT switch, on the overhead panel, controls the brightness of all the annunciator lights on the flight deck.

It sets the brightness of all annunciator lights at the same level.

The flight crew can test the annunciator lights by selecting the TEST position on the ANN LT switch, and check to see that all the annunciator lights come on.

Dome lights

Two dome lights give the cockpit shadow-free illumination.

Mapholder lighting

Each pilot's station has a lighted map and chart holder.

Console and briefcase lighting

Each pilot's station has lighting for the briefcase stowage, the side console, and the floor.

Center instrument panel

Lights under the glareshield illuminate the center instrument panel.

Standby compass

The standby compass has integral lighting.

Reading lights

Each pilot's station has a reading light.

Pedestal lighting

A flood light in the middle of the overhead panel illuminates the center pedestal.

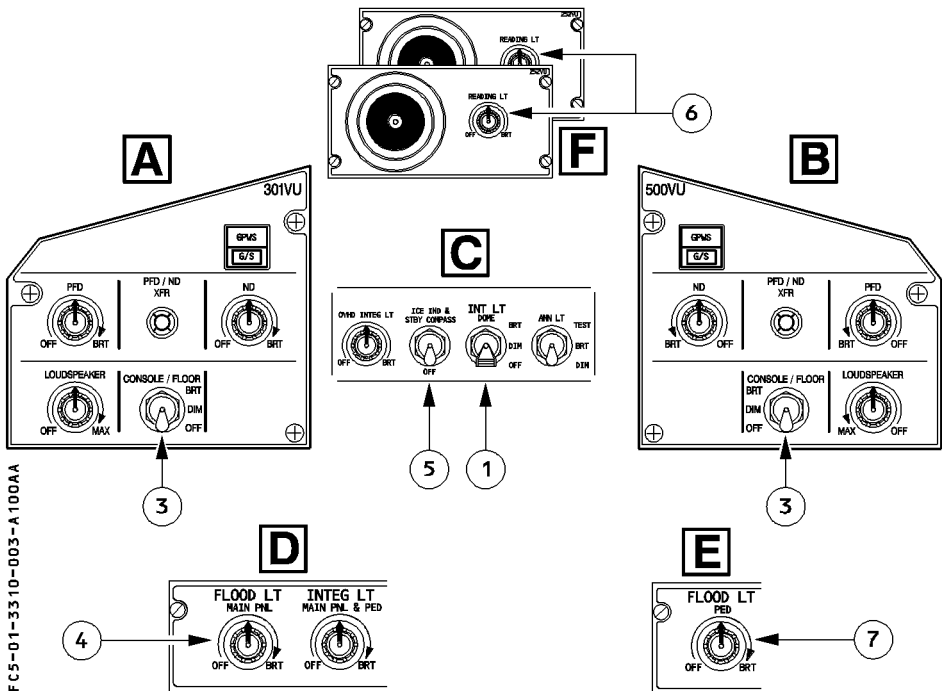
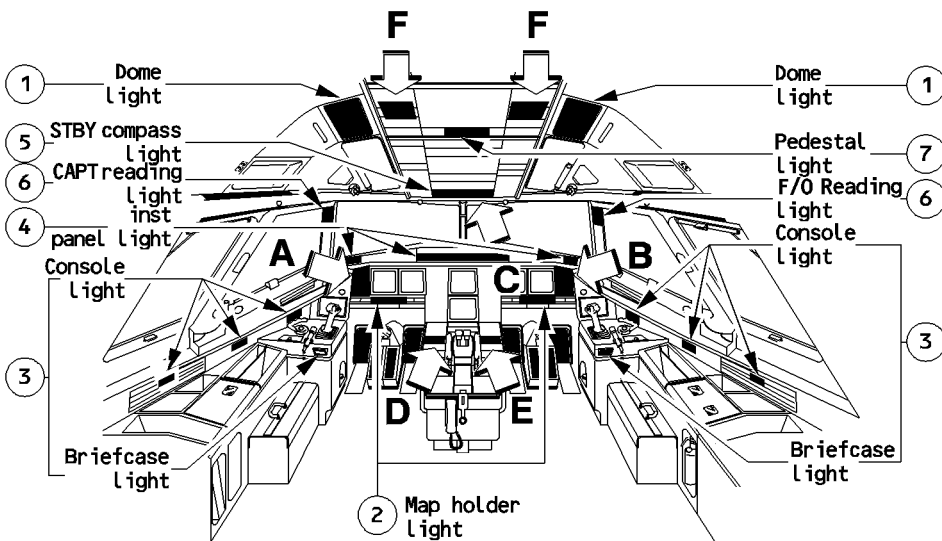

NFC5-01-3310-003-A100AA

CONTROLS AND INDICATORS

OVERHEAD PANEL

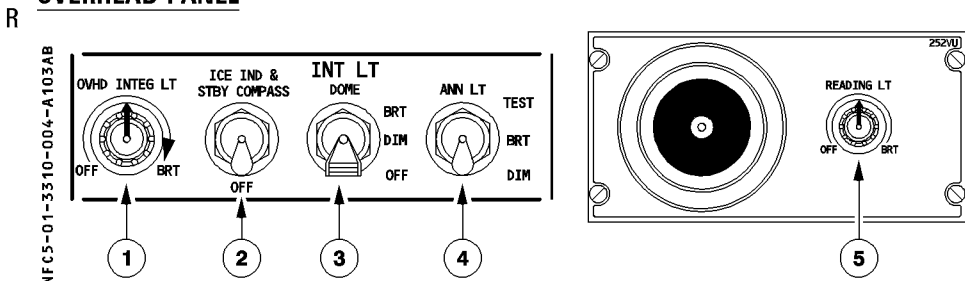

① OVHD INTEG LT knob

This knob turns the integral lighting for the overhead panel on and off and adjusts its brightness.

② ICE IND & STBY COMPASS sw

This switch turns the integral lighting for the standby compass and the visual indicator on and off.

③ DOME switch

This switch controls both dome lights.

BRT : Both dome lights on bright.

DIM : Both dome lights on dim.

OFF : Both dome lights off.

④ ANN LT switch

This switch sets the brightness of all the cockpit annunciator lights at either “bright” or “dim”, and also tests them.

TEST : Illuminates all flight deck annunciator lights.

Puts 8's up in all liquid crystal displays (LCDs).

DIM : Reduces voltage to all annunciator lights.

BRT : Allows annunciators to function normally.

Note : Transfer of data between ECAM and the ND and switching between the electronic instrument system and the display management computer are not allowed during the ANN LT test.



5 READING LT knob

The reading light on each side of the overhead panel has its own control knob that turns it on and off and adjusts its brightness.

MAINTENANCE PANEL

NFC5-01-3310-005-A100AA

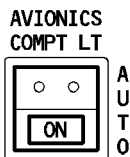

AVIONICS COMPT LT pushbutton switch

AUTO : avionic compartment lighting is automatically controlled by door opening.

ON : avionic compartment lighting is on.

LATERAL WINDOW

NFC5-01-3310-005-B100AA

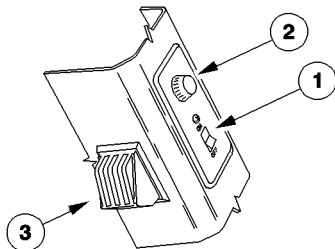

① Reading light switch (Captain and F/O).

② Brightness adjustment

③ Light



PEDESTAL

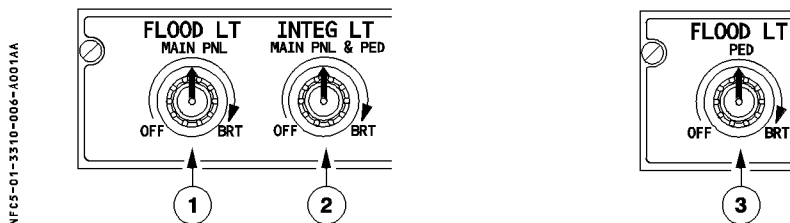

① FLOOD LT MAIN PNL knob

This knob adjusts the brightness of the flood lighting for the center instrument panel, and turns it on and off.

② INTEG LT MAIN PNL and PED knob

This knob adjusts the brightness of integral lighting for the main panel and pedestal, and turns it on and off.

③ FLOOD LT PED knob

This knob adjusts the brightness of the flood lighting for the pedestal, and turns it on and off.



GLARESHIELD

NFC5-01-3310-007-A100AA

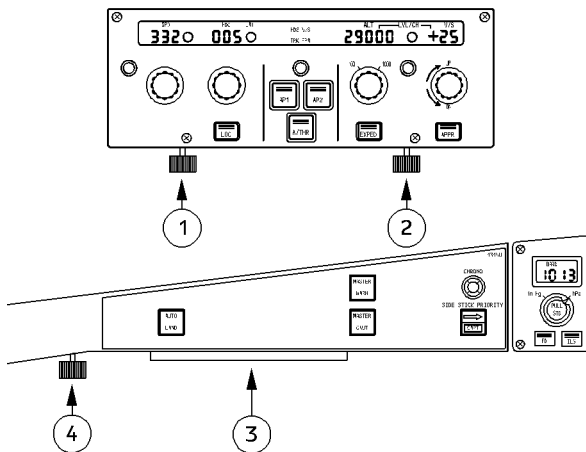

- ① This knob adjusts the brightness of the integral lighting on the glareshield, and of the LEDs on the FCU.
- ② This knob adjusts the brightness of the FCU displays.
- ③ This lighting illuminates the sliding table and map holder.
- ④ This knob adjusts the brightness of the sliding table and map holder lighting.

MAIN INST PANEL

NFC5-01-3310-007-B100AA

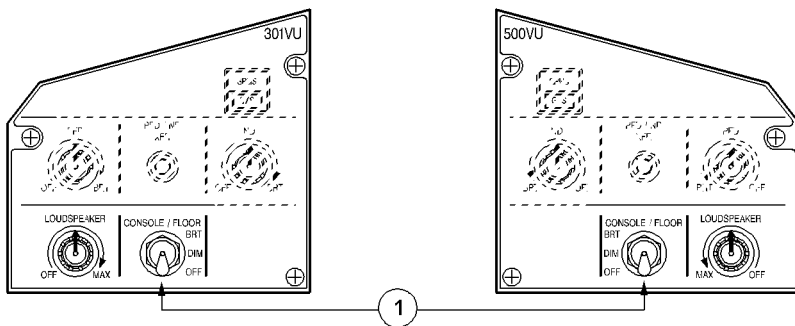

- ① **CONSOLE/FLOOR** switch

Each of these switches controls the lights for the side console and briefcase on one side of the cockpit, and for the floor around one of the pilot's seats. The lights can either be bright, dim, or off.

 AIRBUS TRAINING A320 SIMULATOR FLIGHT CREW OPERATING MANUAL	LIGHTS EXTERIOR LIGHTING	1.33.20	P 1
		SEQ. 001	REV 23

GENERAL

Exterior lighting includes :

- navigation lights
- landing lights
- runway turn off lights
- TO and TAXI lights
- logo lights
- anticollision lights
- wing and engine scan lights

Switches on the overhead panel control the exterior lighting.



CONTROLS AND INDICATORS

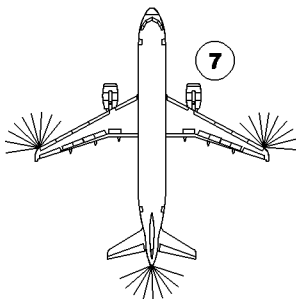
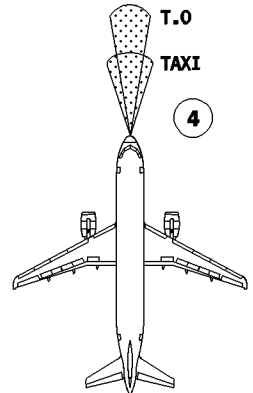
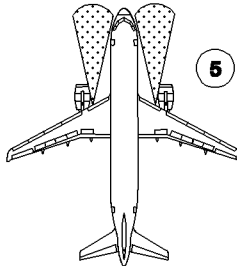
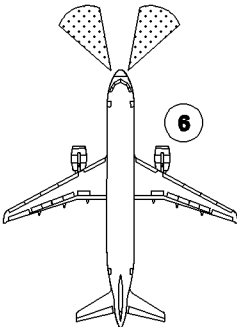
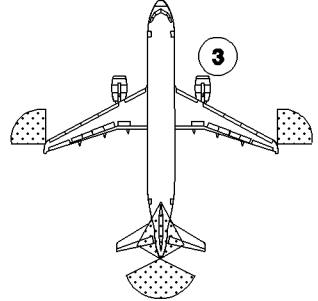
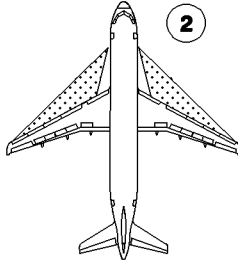
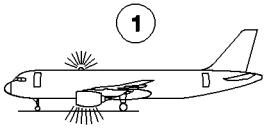

NFCS-01-3320-002-A200AA



OVERHEAD PANEL

NFC5-01-3320-003-A303AA

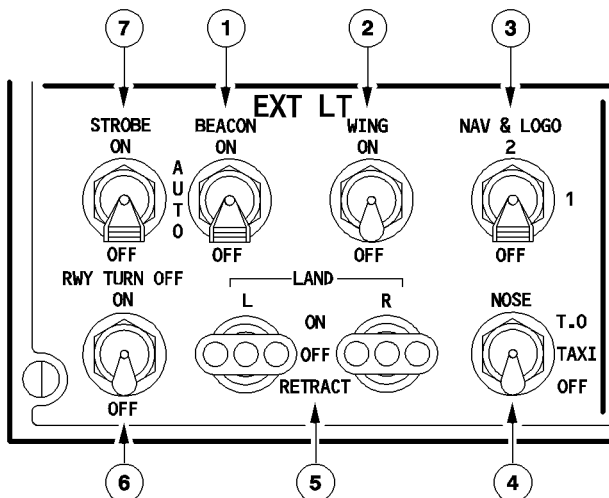

① BEACON sw

This switch turns on and off the two flashing red lights, one on top and one on the bottom of the fuselage.

② WING sw

This switch turns on and off two beam lights on each side of the fuselage. These lights illuminate the leading edge of the wing and the engine air intake to show if ice is accumulating there.

R ③ NAV and LOGO sw

R This switch turns the navigation lights on and off.

R There are dual navigation lights on each wing tip and in the APU tail cone.

R Logo lights are installed in the upper surface of each horizontal stabilizer to illuminate the company logo on the vertical stabilizer provided the main gear struts are compressed or the slats are extended.

R 1 : Turns on the logo lights and the first set of navigation lights.

R 2 : Turns on the logo lights and the second set of navigation lights.

R OFF : All lights are off.

 AIRBUS TRAINING A320 SIMULATOR FLIGHT CREW OPERATING MANUAL	LIGHTS	1.33.20	P 4
	EXTERIOR LIGHTING	SEQ 100	REV 23

④ NOSE sw

This switch turns the taxi and takeoff lights on and off.

T.O. : Turns on both taxi and takeoff lights.

TAXI : Turns on only taxi light.

OFF : Taxi and takeoff lights off.

Note : These two lights, attached to the nose gear strut, go off automatically when landing gear is retracted.

⑤ L and R LAND sel

These selectors control the landing light.

ON : Extends the (left or right) landing light which comes on automatically when fully extended.

OFF : Shut off the landing light but leaves it extended.

RETRACT : Retracts the landing light and shuts it off.

⑥ RWY TURN OFF sw

This switch turns the runway turn-off lights on and off.

Note : These lights go off automatically when landing gear is retracted.

⑦ STROBE sw

This switch turns on and off the three synchronized strobe lights, one on each wing tip and one below the tail cone.

ON : The strobe lights flash white.

AUTO : The strobe lights come on automatically when the main gear strut is not compressed.

OFF : The strobe light are off.

 A320 <small>SIMULATOR</small> FLIGHT CREW OPERATING MANUAL	LIGHTS	1.33.30	P 1
	EMERGENCY LIGHTING	SEQ 001	REV 31

DESCRIPTION

The emergency lighting system has :

- Proximity emergency escape path marking systems (escape path and exit markers),
- Overhead emergency lights,
- EXIT signs,
- Lavatory auxiliary lights,
- Overwing escape route lighting, and
- Escape slide lighting.
 - EXIT signs come on, if the cabin altitude is too high, or (depending on the CIDS/CAM programming), if the NO SMOKING signs come on.
 - The proximity emergency escape path marking system, overhead emergency lighting, and EXIT signs come on, if the EMER EXIT LT selector is ON, or if the EMER pushbutton on the Purser's panel is pressed.
 - With the EMER EXIT LT selector at ARM :
 - The proximity emergency escape path marking system and the overhead emergency lighting automatically come on, if :
 - Normal aircraft electrical power system fails, or
 - DC SHED ESS BUS fails, or
 - AC BUS 1 fails.
 - Exit signs automatically come on, if :
 - Normal aircraft electrical power system fails, or
 - DC SHED ESS BUS fails.
 - When on, the proximity emergency escape path marking system, the overhead emergency lights, and the EXIT signs are normally supplied by the DC SHED ESS BUS. If the DC SHED ESS BUS fails, batteries inside the light fixtures power all the lights. Normally the DC SHED ESS BUS charges the batteries when :
 - The EMER LT selector is not ON, and
 - The EMER pushbutton on the Purser's panel is not pressed, and
 - AC BUS 1 is supplied, and



R Lavatory auxiliary lights are always on. They are supplied by 28V DC ESS BUS. The escape slides have an integral lighting system. The escape slide lights and the overwing route lights come on automatically, when the slide is deployed. They are supplied by internal batteries.

PROXIMITY EMERGENCY ESCAPE PATH MARKING SYSTEM/EXIT SIGNS

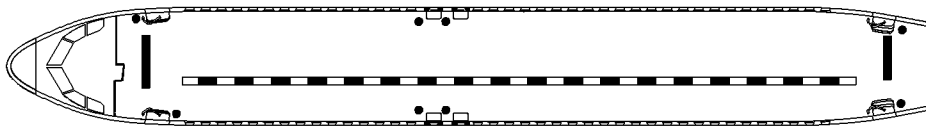
R



LEGEND

-  PROXIMITY EMERGENCY ESCAPE PATH MARKING SYSTEM
-  LIGHT STRIPS IN GALLEY AREA 
- EXIT MARKERS

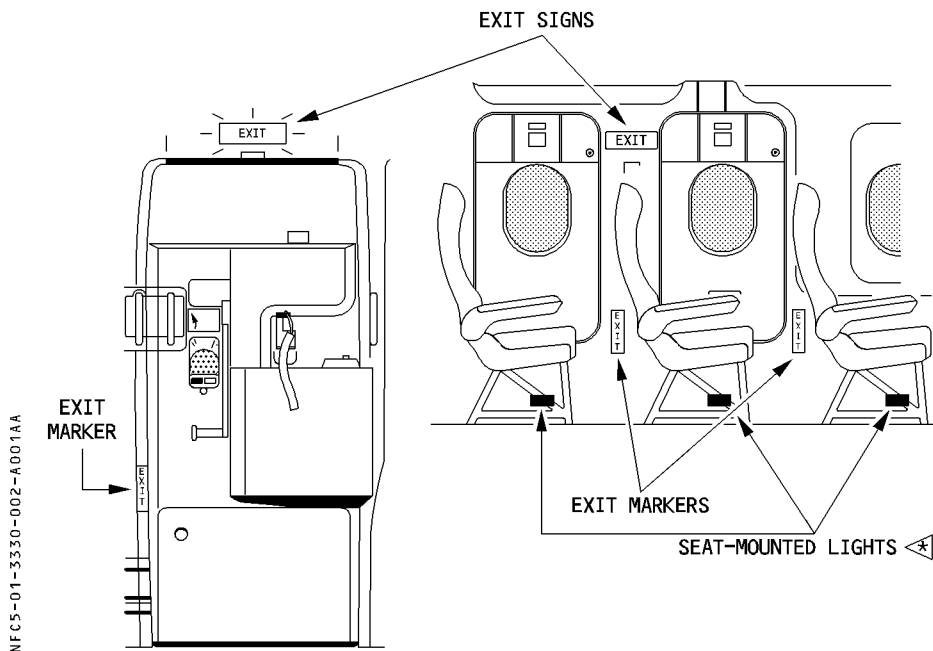

NFC5-01-3330-002-A001AA



EMERGENCY LIGHTING CONTROL LOGIC

FOR INFO

R

OVERHEAD EMER LIGHTS	PROX MARKING SYSTEM	EXIT SIGNS	ELEC SUPPLY
ON	ON	ON	DC SHED ESS OR INT. BAT.
ON	ON	ON	INT. BAT.
ON	ON	OFF	DC SHED ESS
ON	ON	OFF	DC SHED ESS
OFF	OFF	ON	DC SHED ESS

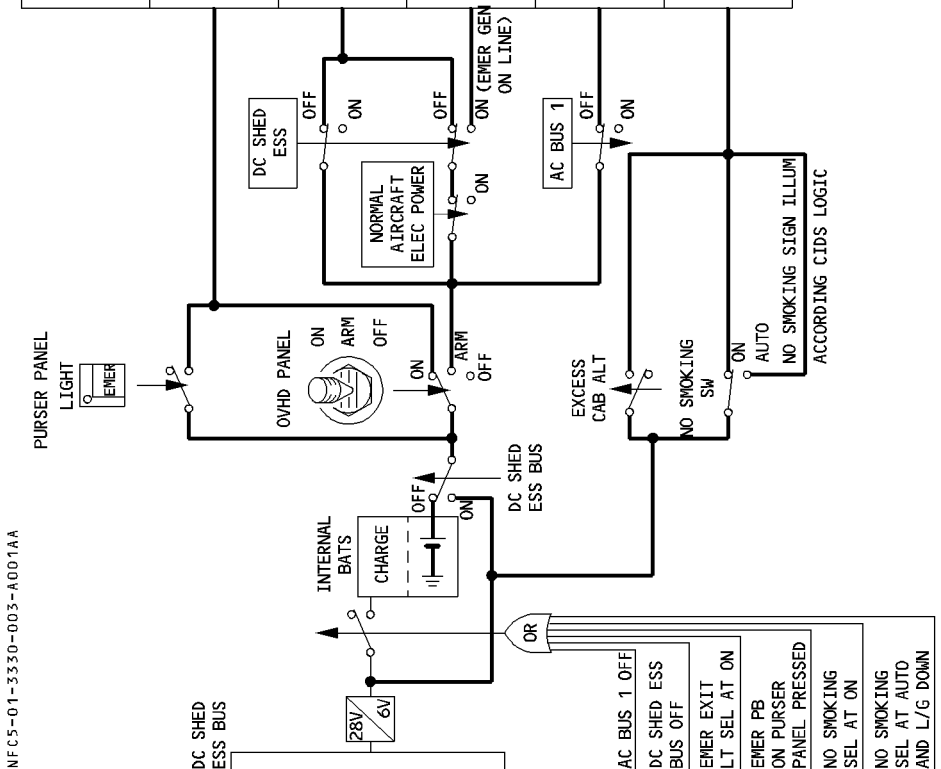

CONTROLS AND INDICATORS

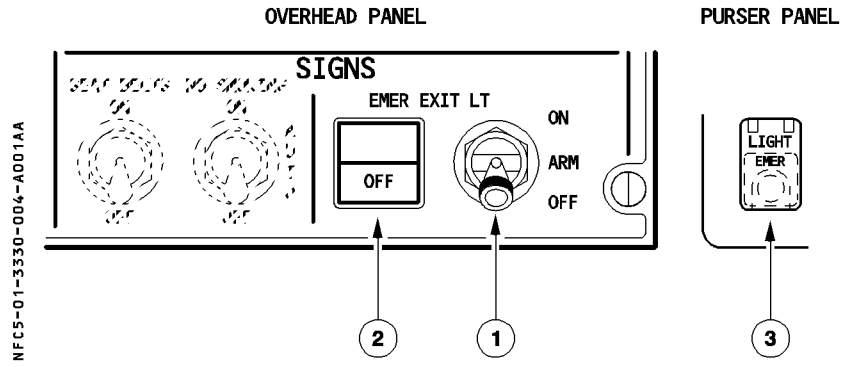

① EMER EXIT LT sel

The selector has three detent positions.

- R ON : Overhead emergency lights, EXIT signs and proximity marking system come on.
- R OFF : Above lights are off.
- R ARM : The proximity emergency escape path marking system and overhead
- R emergency lighting come on if :
 - Normal aircraft electrical power system fails or
 - DC SHED ESS BUS fails or
 - AC BUS 1 fails.
- R Exit signs come on if :
 - Normal aircraft electrical power system fails or
 - DC SHED ESS BUS fails or

Note : The LIGHT EMER pushbutton on the purser's panel can turn on the emergency lighting independently of the positions of this selector switch.

② EMER EXIT LT-OFF It

This light comes on amber when the EMER EXIT LT selector is selected OFF.

③ LIGHT EMER pb

When pressed, this button performs the same function as the EMER EXIT LT switch when it is ON.



CONTROLS AND INDICATORS

OVERHEAD PANEL

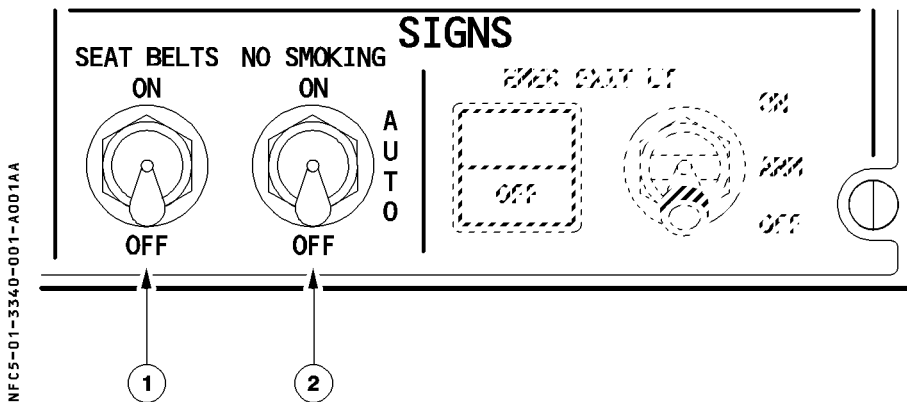

① SEAT BELTS sw

- R ON : FASTEN SEAT BELT and RETURN TO SEAT signs come on together with a low tone chime.
- R OFF : Signs are off. Low tone chime sounds upon extinction of lights (depending on the CIDS/CAM programming).

② NO SMOKING sel

- R ON : NO SMOKING and EXIT signs come on together with a low tone chime.
- R AUTO : NO SMOKING and EXIT signs come on when landing gear is extended and go off when landing gear is retracted. Low tone chime sounds (depending on the CIDS/CAM programming) when the lights go on or off.
- R OFF : Signs are off. Low tone chime sounds upon extinction of lights (depending on the CIDS/CAM programming).

Note : If the cabin altitude goes above 11300 feet (\pm 350 feet), the cabin illuminates (depending on the CIDS/CAM programming) and the NO SMOKING, FASTEN SEAT BELT, EXIT signs come on regardless of SEAT BELTS and NO SMOKING selector switches.

 AIRBUS TRAINING A320 SIMULATOR FLIGHT CREW OPERATING MANUAL	LIGHTS	1.33.40	P 2
	SIGNS	SEQ 100	REV 34

MEMO DISPLAY

- Displays “LDG LT” in green, if one landing light is extended.
- Displays “STROBE LT OFF” in green, if the STROBE switch is OFF in flight.
- Displays “SEAT BELTS” and “NO SMOKING” messages in green, when the corresponding sign is on.



BUS EQUIPMENT LIST

			NORM		EMER ELEC		
			AC	DC	AC ESS	DC ESS	HOT
COCKPIT LIGHTS	Dome light	L		DC GND/ FLT			
		R				X	
	Console light	L		DC1			
		R		DC2			
	Main inst panel	L				X	
		R		DC1			
	Stby compass/ice ind					X	
	Supplementary reading light			DC1			
	Pedestal light			DC1			
	Reading light	L		DC1			
		R		DC2			
	Briefcase light	L		DC1			
		R		DC2			
	Map holder light	L		DC1			
		R		DC2			
	Floor light			DC1			
	Inst, panels-integral light			AC1			
	Annunciator light			AC1, 2 and AC STAT INV			
Annunciator light test/dim			DC2				

		NORM		EMER ELEC		
		AC	DC	AC ESS	DC ESS	HOT
EXTERIOR LIGHTS	Navigation Its	GRD/ FLT				
	Landing Its L	AC1				
	Landing Its R	AC2				
	RWY turn off Its L	AC1	DC 2 *			
	RWY turn off Its R	AC2	DC 2 *			
	Taxi and TO Its	AC1	DC 2 *			
	Taxi and TO Its	AC2	DC 2 *			
	Logo Its L <◁	AC1	DC 2 *			
	Logo Its R <◁	AC2	DC 2 *			
	Beacon Its Upper	AC1				
	Beacon Its Lower	AC2				
	Strobe Its <◁	AC2				
	Wing Its R	AC1				
Wing Its L	AC2					
CABIN LIGHTING		AC1 AC2 and GRND/ FLT			SHED **	

* Supply for the light control

** Standby supply (refer to EMERGENCY LIGHTING CONTROL LOGIC)